

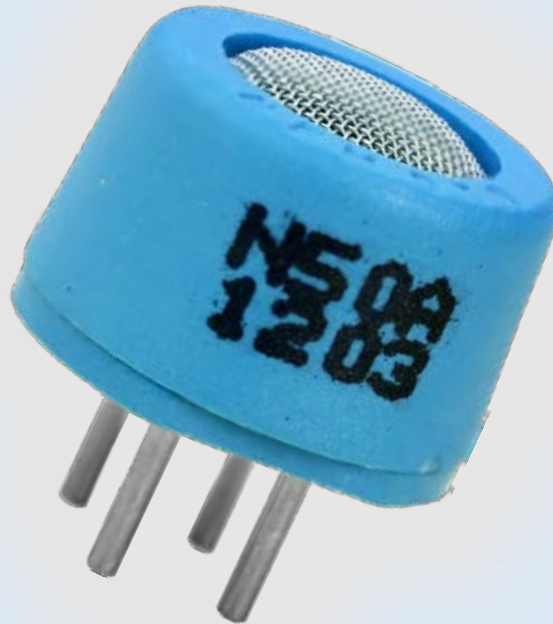

Operating Characteristics and Handling Manual for the NAP-55A / NAP-50A Explosive/Flammable Gas Sensor

**Nemoto Sensor
Engineering Co., Ltd.
4-10-9, Takaido-higashi,
Suginami-ku, Tokyo,
JAPAN**



The NAP-55A Gas Sensor is a low-cost Catalytic Flammable Gas Sensor designed for the detection and measurement of Methane or Natural Gas in the range 0-50% LEL. Developed primarily for use in Residential Gas Detectors, the NAP-55A has also been found to be useful in a wide variety of other applications where reliable detection of gas leaks and other gas hazards is required at low cost.

The NAP-50A sensor is a special, modified version of the NAP-55A, modified to reduce the effect of potential cross-sensitive gases likely to be encountered in domestic premises, particularly Ethanol, in compliance with the European standard for Residential Gas Detectors EN 50194.

The NAP-50A should therefore only be selected if high sensitivity to Natural Gas or Methane only is required, and the lowest cross-sensitivity to other flammable gases and vapours is desirable. Where maximum sensitivity to all flammable gases is required, The NAP-55A should be used.

The operating characteristics and performance of the two sensors are virtually identical, apart from the cross-sensitivity effects noted above. This manual is therefore considered by Nemoto to apply equally to both types.

The NAP-55A / NAP-50A uses the superior catalytic “pellistor” detection principle often used in high quality Industrial Gas Detectors. It hence has many benefits over other low-cost gas sensor types.

Nemoto has a policy of continuous development and improvement of its products. As such the specification for the device outlined in this document may be changed without notice.

nap-55a-manual, issue 5, December 2015



Contents

Principles of Operation.....	3
General Specifications.....	4
Outline Drawing, Dimensions and Materials of Construction.....	5
Performance Measurements.....	6
Gas Sensitivity.....	6
Responses to Gases other than Methane.....	6
Response Time Characteristics.....	7
Temperature Dependence.....	8
Wind and Flow-Rate Influences.....	8
Long Term Stability.....	9
Tolerance to Catalyst Poisons.....	10
Shock Resistance.....	10
Accelerated Lifetime Tests.....	11
Notes on Sensor Testing.....	12

Note that the performance measurements expressed in this document should be considered as typical characteristics observed by Nemoto's own Engineers, and are for guidance only, and not as specifications which are guaranteed, apart from those in the sections "General Specifications" and "Dimensions" (Pages 4 and 5). It is the instrument designer's responsibility to ensure that the sensor is suitable for any given application.



Principles of Operation:

Catalytic combustion has been the most widely used method of detecting flammable gases in Industry since the invention of the catalysed pelletized resistor (or "Pellistor") over 40 years ago.

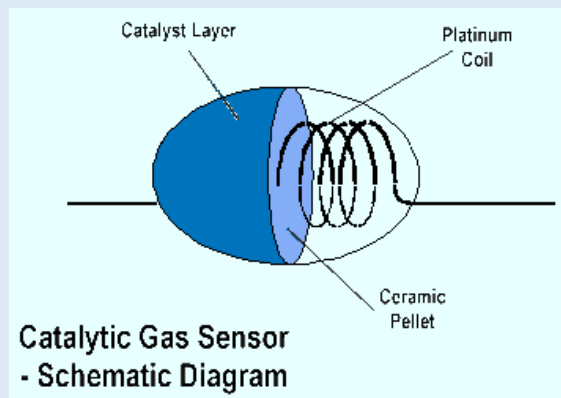

A catalytic pellistor type gas sensor consists of a very fine coil of platinum wire, embedded within a ceramic pellet. On the surface of the pellet is a layer of a high surface area noble metal, which, when hot, acts as a catalyst to promote exothermic oxidation of flammable gases. In operation, the pellet and so the catalyst layer is heated by passing a current through the underlying coil. In the presence of a flammable gas or vapour, the hot catalyst allows oxidation to occur in a similar chemical reaction to combustion. Just as in combustion, the reaction releases heat, which causes the temperature of the catalyst together with its underlying pellet and coil to rise. This rise in temperature results in a change in the electrical resistance of the coil, and it is this change in electrical resistance which constitutes the signal from the sensor.

Pellistors are always manufactured in pairs, the active catalysed element being supplied with an electrically matched element which contains no catalyst and is treated to ensure no flammable gas will oxidise on its surface. This "compensator" element is used as a reference resistance to which the sensor's signal is compared, to remove the effects of environmental factors other than the presence of a flammable gas.

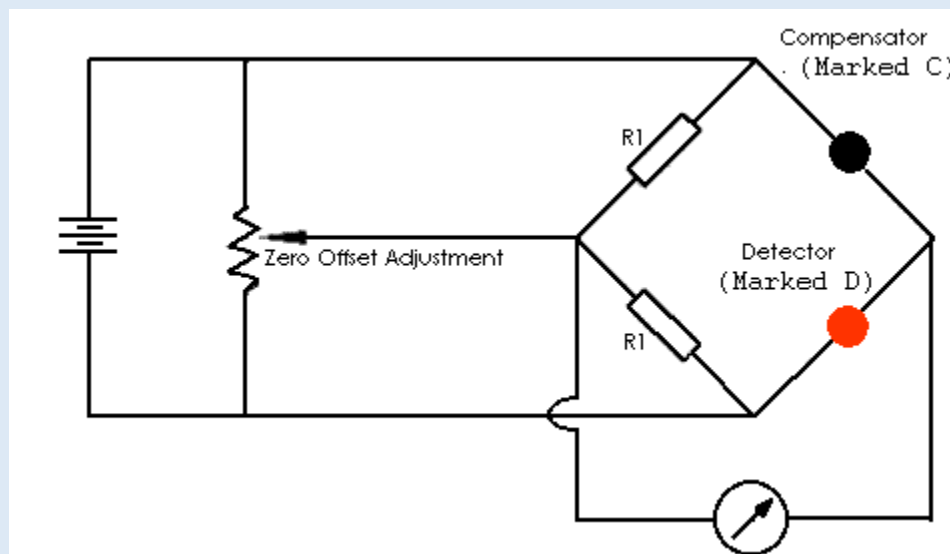

Pellistor Drive/Measurement Circuit: A simple Wheatstone Bridge to compare the resistance of two hot elements



The advantage of using this technique when detecting flammable gases for safety purposes is that it measures flammability directly.

Nemoto provides matched pair Pellistors conveniently mounted in a variety of enclosures for different applications. Some of these options contain the detector and compensator elements in separate enclosures (the NP range for Industrial applications). In the case of the NAP-55A and NAP-50A, both elements are contained within a plastic enclosure for ease of use and low cost.

Catalytic pellistor type gas sensors have many advantages to semiconductor type gas sensors

- ❖ Linear output in proportion to gas concentration
- ❖ Greater Stability
- ❖ Higher reproducibility
- ❖ Gas specific - will only respond to flammable gases
- ❖ Unaffected by humidity
- ❖ Stable output for long periods
- ❖ More resistant to shocks and vibrations.

General Specifications:

Operating Specifications:	
Detected Gases	Flammable Gases (All specifications are based on the detection of Methane/Natural Gas)
Standard Concentration Range	0 – 2.5% Methane in Air (0-50% LEL)
Recommended Bridge Voltage	2.5V +/- 0.25V
Current Consumption (at Recommended Bridge Voltage)	170mA +/- 10mA
Bridge zero offset	0 +/- 35mV
Output Sensitivity	37-53mV for 1% CH4
Linearity	Effectively Linear to 50% LEL
Response Time (Measured as T90)	<10 secs
Accuracy (Measured as Repeatability)	± 0.5mV for Zero ± 0.5mV for Gas Sensitivity
Long Term Stability Drift	Zero: Less than +/- 2mV per year Sensitivity: Less than +/- 2mV per Month
Expected Lifetime in the field	Over 5 Years. (In an appropriate Residential or Light commercial application)
Environmental Specifications:	
Temperature Range	-10°C to +50°C
Standard constant Humidity Range	15 to 90%RH
Standard Constant Pressure Range	1atm ± 10%
Recommended storage Temperature Range	0 to 20 degree C
Recommended Maximum Storage Time	6 months
Mechanical Data	
Enclosure Material	20% Glass Reinforced Nylon 66
Connector Pin Material	Nickel
Protective Mesh Material	316 SS



Dimensions

Sensor : NAP-55A / NAP-50A

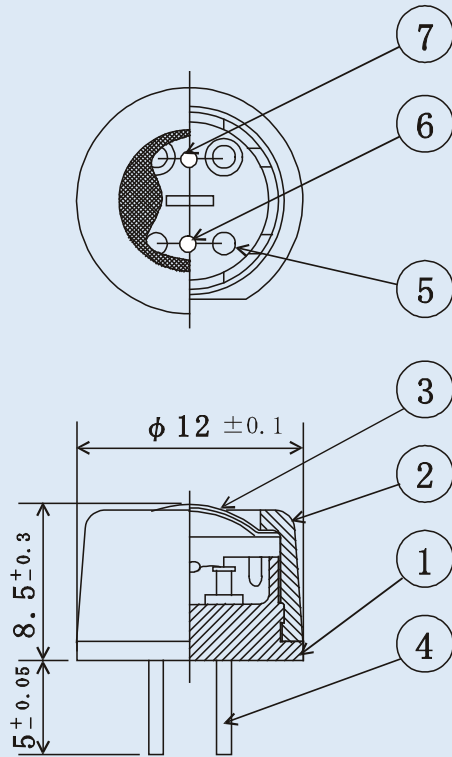

Detector mark

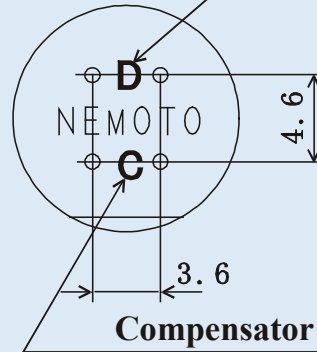

Compensator mark

Bottom view

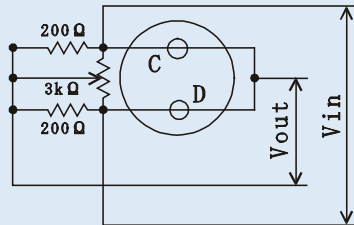

Measuring Circuit

No.	Parts names	Material	Remarks
1	Mount	Nylon 66	Glass 20% contained
2	Cap	Nylon 66	Glass 20% contained
3	Mesh	SUS 316	#100, Double mesh
4	Pin	Pure Ni	$\phi 0.8$
5	Coil	PPT	$\phi 30\mu m$
6	Compensator		Nemopto & Co.,Ltd
7	Detector		Nemopto & Co.,Ltd

THIRD ANGLE PROJECTION	APPROVED	CHECKED	DESIGNED	DRAWN	MATERIAL	Q.TY	SCALE
	TITLE				DATE	DRG.NO.	
	NAP-55A				DEC, 25, 1993	G-01-04-143	
					NEOTO & CO., LTD		



Performance Measurements

Gas sensitivity

The graph below shows the sensitivity characteristics for methane, with standard deviation limits to illustrate the excellent repeatability of this characteristic from sensor to sensor.

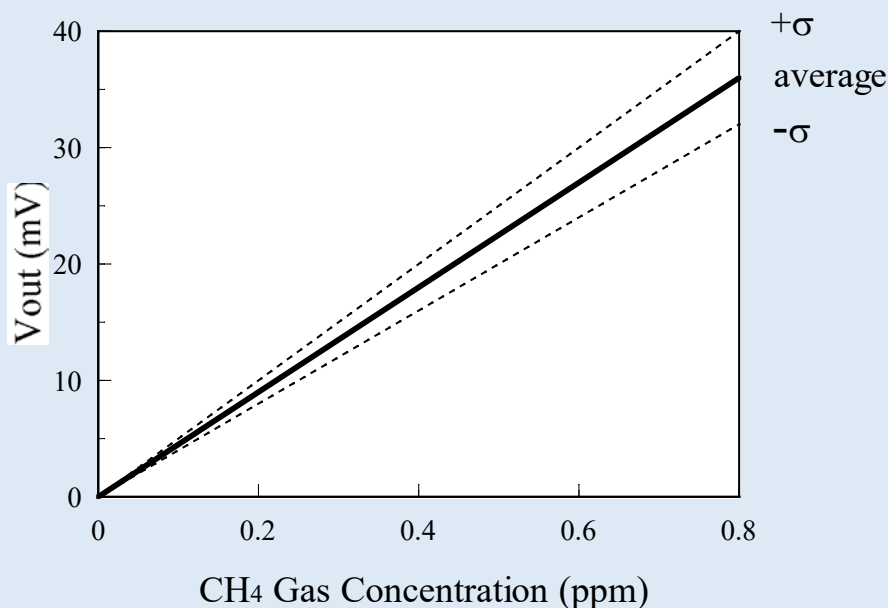

Sensitivity to gases other than Methane

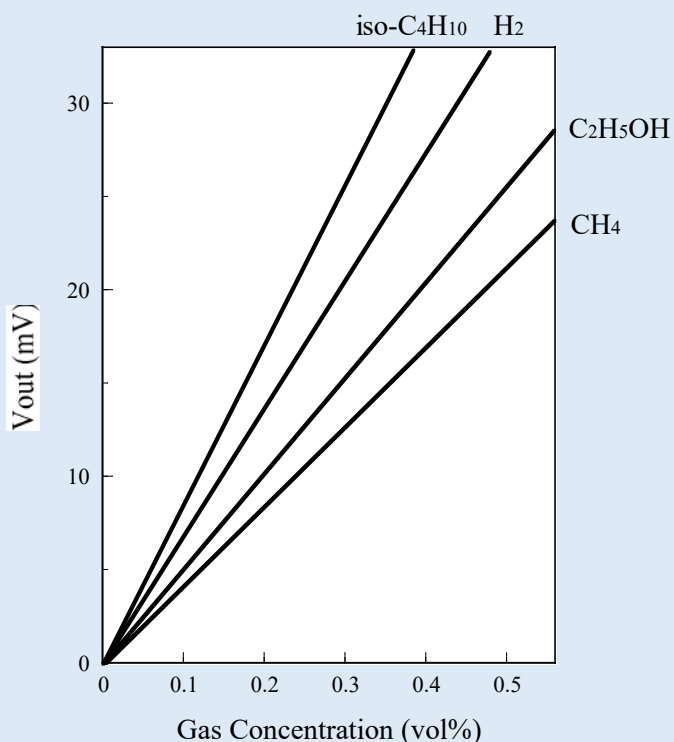

The graph opposite shows the relative sensitivity Characteristics of the NAP-55A for the flammable gases Methane, Iso-Butane, Hydrogen and Ethanol.

For other flammable gases, Nemoto can advise on the anticipated sensitivity of the sensor alone, but since the relative sensitivities to various gases is also dependent on the mounting arrangement within an instrument, it is always recommended that the instrument maker determines the response of the sensor to the target gas by experiment using the final product design wherever possible.

NOTE: This data applies to the NAP-55A sensor only. The NAP-50A sensor exhibits lower relative sensitivity to gases other than Methane, and so the NAP-50A version should not be used for the detection any gas other than Methane / Natural Gas



Response Time Characteristics

The figure below shows the typical response and recovery characteristics of the NAP-55A / NAP-50A when exposed to a step change of 3000ppm Methane in air. The graph here compares this response to that of an earlier and now obsolete Nemoto device, the NAP-2A.

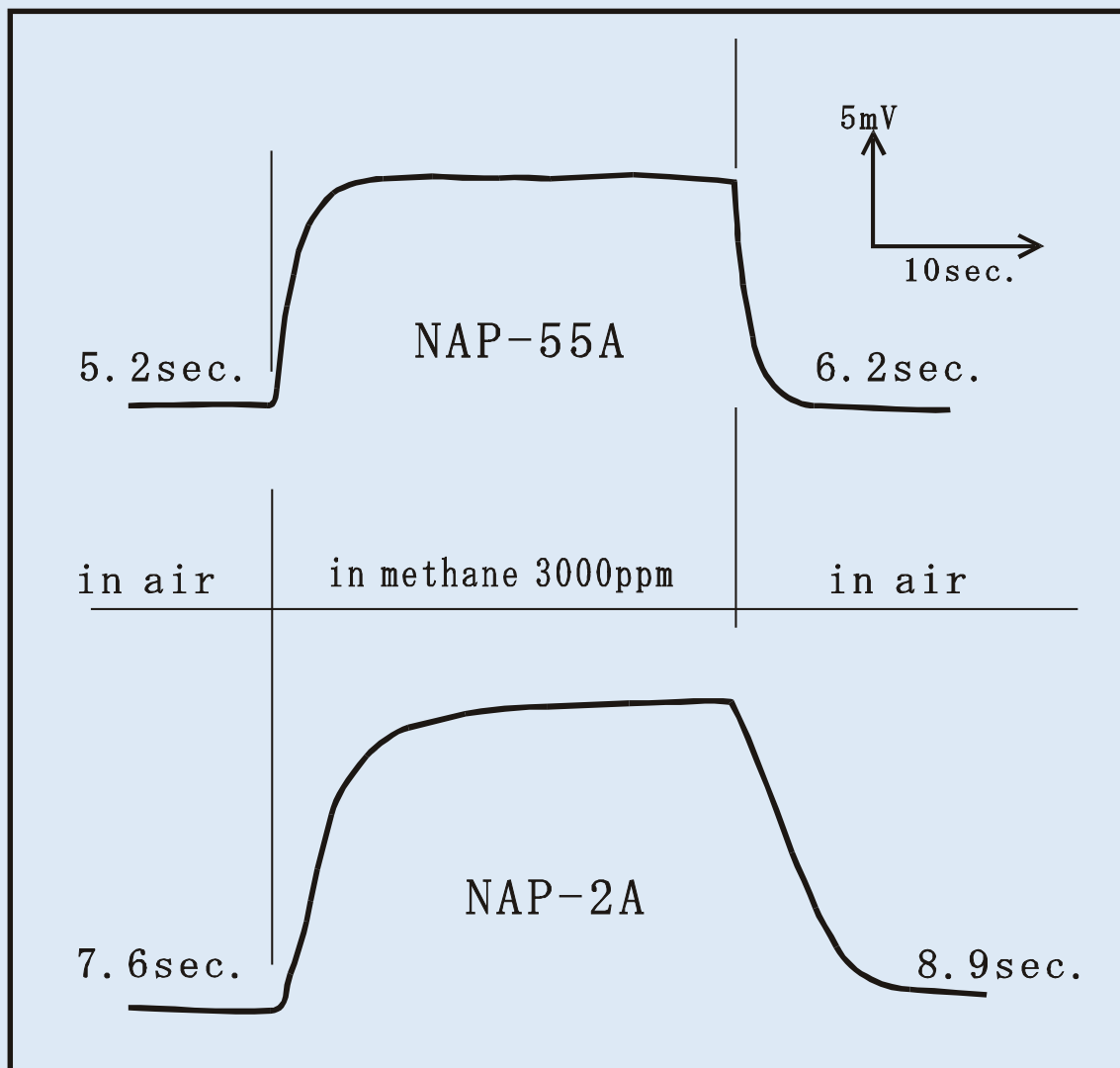



Temperature Dependence

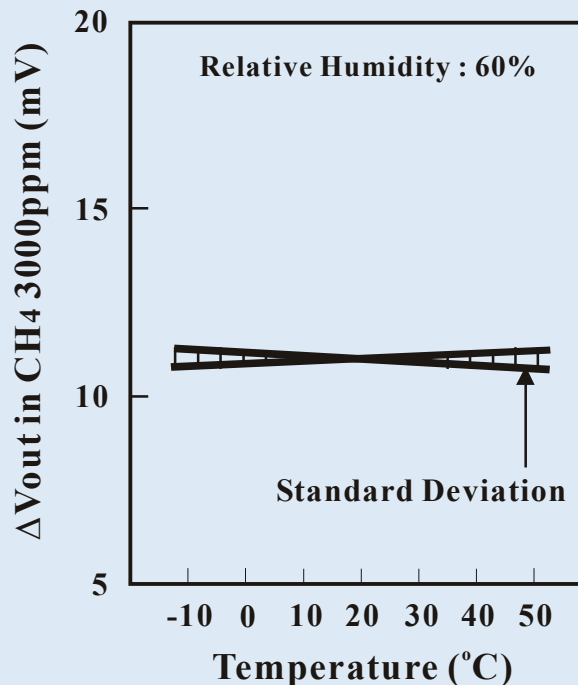
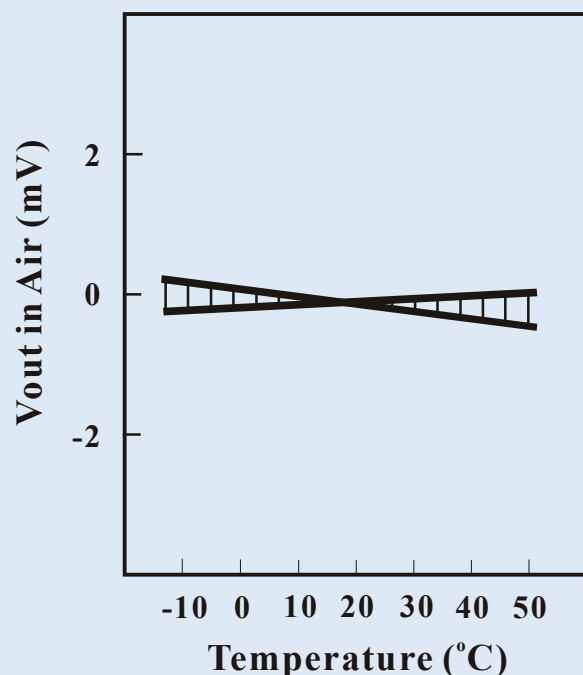

Wind and Flow-Rate Influences

All pellistor type gas sensors work best when sampling the air around it by diffusion only. Wind and turbulence around the sensor can affect the signal stability of the sensor by:

- a) Changing the speed at which gas can transport to the sensor, and
- b) Locally cooling the detector and/compensator

It is therefore important that the instrument designer seeks to protect the sensor from wind and turbulence far as possible.

The NAP-55A has, however, been carefully designed to minimize the effects of wind and flow of the gas around it, and in tests the following results were found

Wind Direction and Velocity	Typical Observed Deflection/Instability
From sensor side, 1.5m/sec.	Approx. - 1mV
From sensor side, 3.0m/sec.	Approx. - 1mV
From compensator side, 3.0m/sec.	Approx. + 1mV
Parallel to sensor and compensator, 3.0m/sec.	Approx. +/-1mV
From top, 3.0m/sec.	Approx. +/-1mV



Long Term Stability

The plots below indicate the typical long term stability of the NAP-55A / NAP-50A over 90 months (7.5 years) of operation. The first plot indicates the drift in gas sensitivity, the second plot indicates the drift in the zero offset value, and the bottom graph indicates the effect of both of these drifts on the effective alarm concentration for an instrument designed and commissioned with an alarm level of 3000ppm (the standard alarm level for residential gas detectors in Japan).

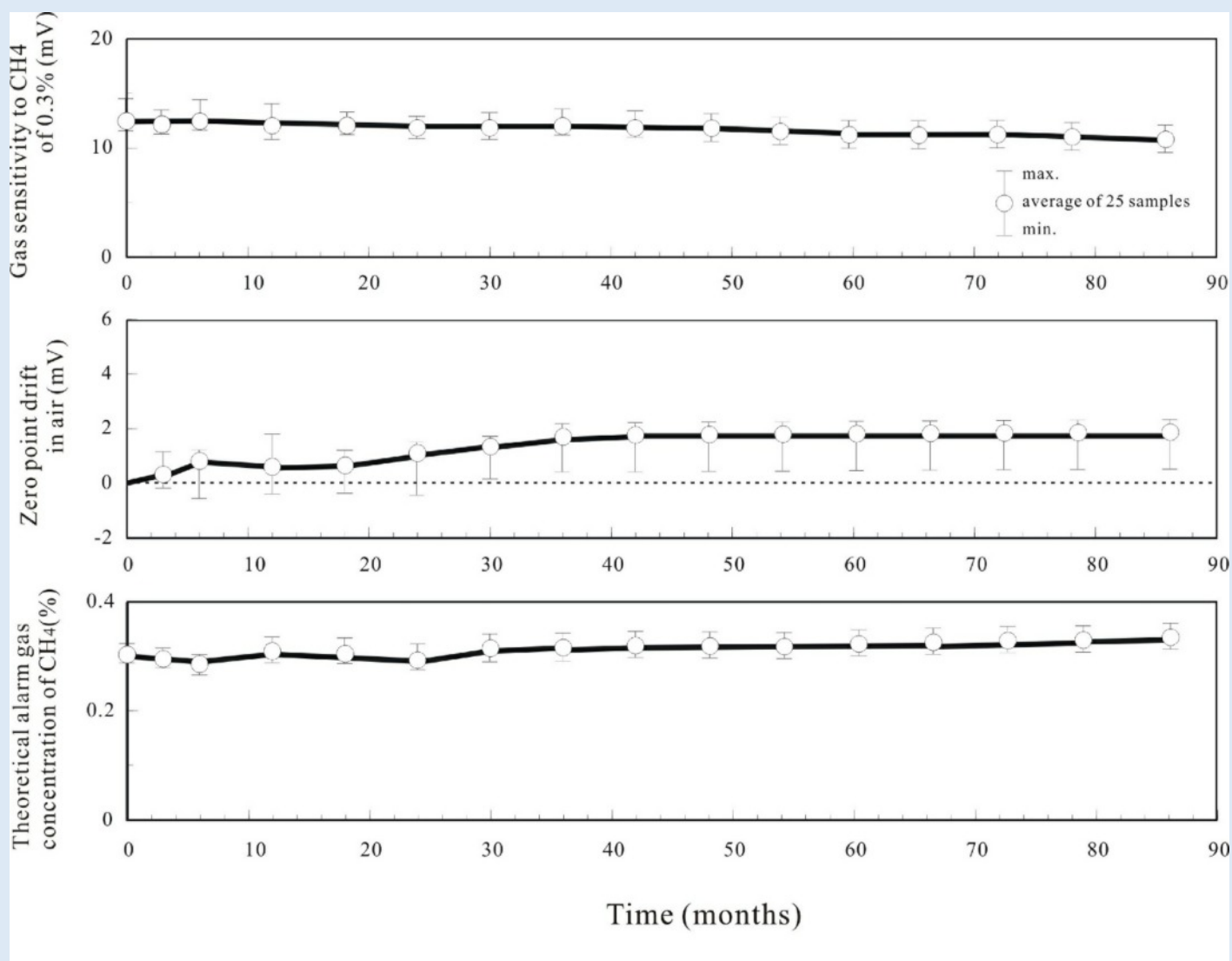



Tolerance to Environmental Extremes

Tolerance to Catalyst Poisons

**This section should read in conjunction with the Nemoto Europe Technical Note:
“Pellistor Gas Sensors and Poisoning”**

10 samples of NAP-55A sensors were exposed continuously to 10ppm Hexamethyldisiloxane (HMDS) for 1 hour. The sensors were then tested for span sensitivity and zero output. The results were compared to those taken before the silicone exposure. The results are tabulated below:

Test samples	Before contamination (mV)		After contamination (mV)	
	Output in air	in 3,000ppm of CH ₄	Output in air	in 3,000ppm of CH ₄
Contamination without power supply				
1	- 14.3	12.5	- 14.2	9.9
2	- 13.3	13.0	- 13.3	11.0
3	- 0.8	12.9	- 1.0	11.1
4	+ 0.2	12.4	+ 0.3	10.5
5	+ 10.4	12.5	+ 10.2	9.5
Contamination with power supply				
6	- 12.2	12.2	- 12.1	9.2
7	- 19.9	13.1	- 19.8	8.9
8	- 15.2	12.8	- 15.0	8.4
9	+ 12.2	12.7	+ 12.1	8.6
10	+ 23.7	12.8	+ 23.8	8.8

An interesting feature of Nemoto Catalytic gas sensors is that they have the ability to recover from exposure to catalyst poisons. Following an exposure to a catalyst poison, provided the exposure is not severe and the sensor is exposed to fresh air or clean combustible gas thereafter, the sensitivity of the sensor will recover near to levels prior to the exposure after a short while.

Shock Resistance

10 samples of NAP-55A sensors, mounted within standard residential instruments, were wired remotely by lying leads to an external circuit. They were each dropped 3 times onto a wooden surface from a height of 50cm. In each case the zero output of the sensor was monitored by an undamped chart recorder, and maximum deviation in zero output was recorded to be as follows:

Sample No.	* Fluctuation compared to initial output (mV)		
	Trial 1	Trial 2	Trial 3
A	+ 1.0	+ 1.3	+ 1.0
B	- 1.5	- 0.8	+ 0.5
C	- 1.1	- 0.5	- 1.2
D	+ 1.4	+ 0.5	- 0.1
E	- 0.3	- 0.4	- 0.8
F	+ 1.0	+ 0.5	+ 1.1
G	- 1.6	- 1.4	- 1.2
H	+ 1.5	+ 1.0	+ 0.8
I	+ 0.5	+ 0.1	- 0.4
J	- 1.3	- 1.0	- 0.7



Accelerated Lifetime Tests

Two different accelerated test regimes have been used in to estimate the typical lifetime a customer may expect from a NAP-55A / NAP-50A type gas sensor.

(1) Overload Voltage test

In this test sensors were continuously energized in a test circuit, but the supply bridge voltages used were 120%, 130%, and 140% of the nominal rated supply voltage. The sensors were stored powered in normal room conditions, then periodically the zero (output voltage in air) was measured using the standard supply voltage of 2.5V. In this test is it assumed that a sensor is deemed to reach the end of its life when the zero output deviates from its original reading by more than +/- 5mV.

By extrapolating the results it is possible to estimate the lifetime of the sensor (using the same criteria) when powered by the recommended supply voltage. The result is mapped in the below graph. This test estimates the typical lifetime of the NAP-55A to be around 8.4 years.

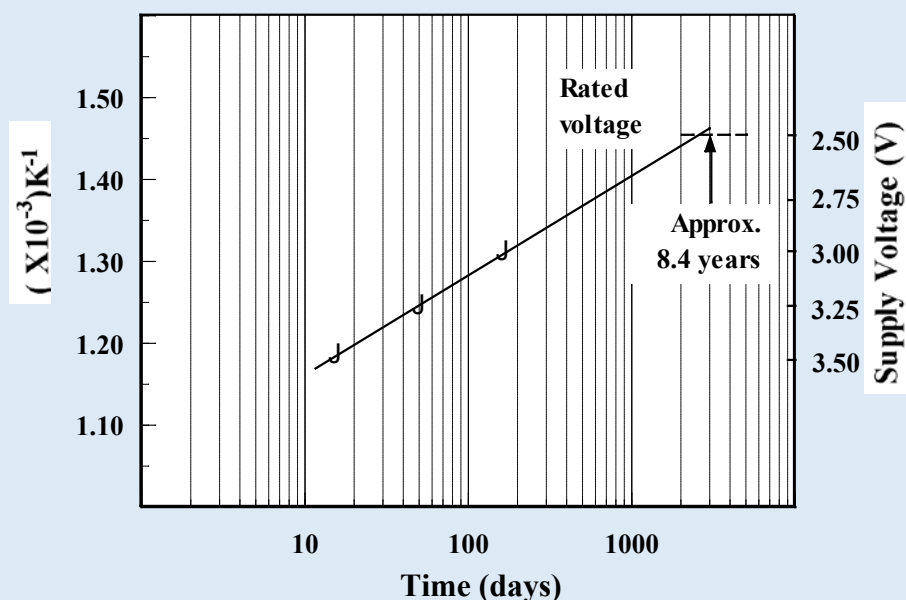

(2) High Temperature and Humidity test

In this test the sensors were energized with the rated voltage of 2.5V, Sensors were energized with the rated voltage, but in this case the sensors were continuously exposed to an atmosphere of 95% RH. In addition, the atmosphere contained enough isopropyl alcohol vapour to maintain the sensor output at a signal level of 150mV. This atmosphere was used at different temperatures (74 deg C, 87 deg C, and 97 deg C).

Periodically the sensors were removed from the test environment and tested for zero and span sensitivity using methane test gas.

In this test the sensors were considered to have reached the end of their useful lifetimes when the signal output had reduced to 50% of its original value. By extrapolating the results at different temperatures it is possible to estimate the lifetime of the sensor (using the same criteria), in conditions of high humidity. The result is mapped in the below graph. This test estimates the typical lifetime of the NAP-55A in high humidity conditions to be around 7.3 years.

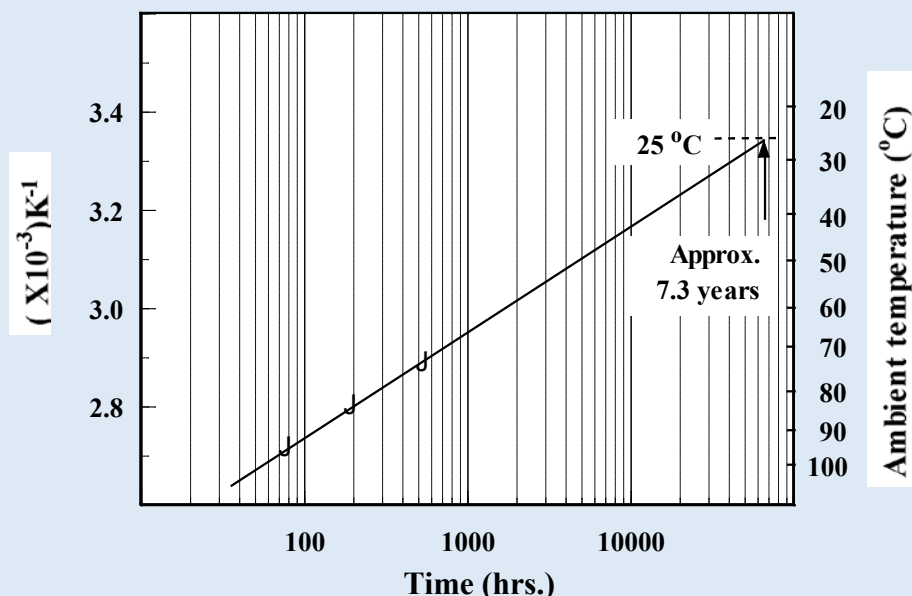

Notes on sensor testing

All Nemoto specifications are based on testing within a gas filled chamber. Testing the sensor using a flow-through system will yield similar, but not identical, results. The Nemoto test set up is illustrated below:

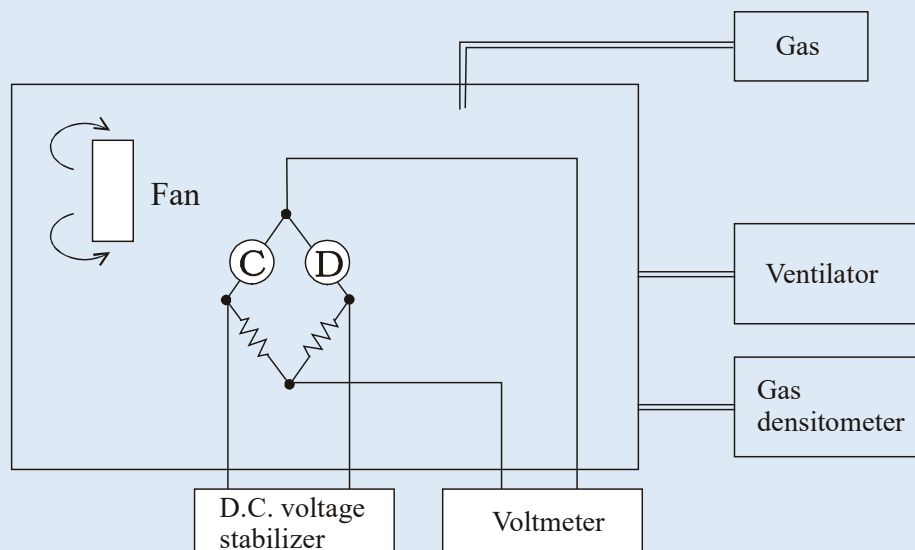

The test chamber is constructed of glass, or another material known not to absorb gases.

In Nemoto's test regime, test gases are introduced into the chamber by injection, following careful calculation of the amount of gas required to generate the required concentration within the chamber. This may also be accomplished by purging the chamber using gas from a test gas cylinder, provided the flow rate used is not high enough to cause turbulence in the chamber.

The gas inside the chamber is gently agitated by a slow moving fan, to ensure that concentration gradients do not develop during testing, either by stratification layers forming in the chamber, or by the consumption of the gas by the sensors themselves.



Other methods, including the use of flow-through hoods and pumped sampling assemblies, may of course be used by instrument manufacturers, but it should be recognised that the method used to expose the sensor to test gas will have a small effect on the accuracy and repeatability of the results obtained, and the correlation of these results with Nemoto's own routine QA test results. If a flow-through method is to be employed, care should be taken to ensure that:

- 1) Materials used in the construction, tubing, flanges, joints etc, should be chosen to not absorb the gases to be used, and are free from catalyst poisoning lubricants or mould release agents such as silicones, which could damage the sensor.
- 2) Flow rates should be carefully calculated so that turbulent flow does not occur in the sensor cavity, and the sensor itself is not subjected to undue back pressure. Flow rates of between 100 ml/min and 400 ml/min are usually appropriate, but it will depend on the design of the assembly.
- 3) Ideally the sensor should sample the gas flowing above it by diffusion only. Gas should not enter the sensor housing by mass-transport caused by pressure fluctuations. This can be accomplished by the use of a porous pfe membrane inserted between the flow of gas and the sensor, which will dampen any pressure fluctuations at the sensor. This is especially important if an electric pump is used.
- 4) The outlet/exhaust of the flow through assembly should allow a non-tortuous exit from the assembly, to avoid back pressure in the sensor cavity.