



**Nemoto Sensor  
Engineering Company Ltd**

4-10-9 Takaido-Higashi  
Suginami-ku  
Tokyo 168-0072,  
Japan

[www.nemoto.eu](http://www.nemoto.eu)

## Datasheet and Technical Manual for the NAP-78SR2 Catalytic gas sensor for the detection of incomplete combustion in boiler flues.

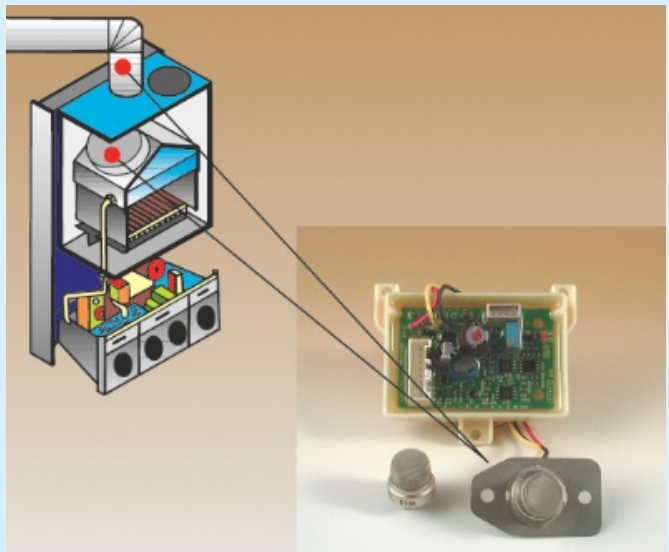

Nemoto has a policy of continuous development and improvement of its products. As such the specification for the device outlined in this document may be changed without notice.



## Contents

<b>Introduction and General Description.....</b>	<b>3</b>
<b>Principles of Operation.....</b>	<b>3</b>
<b>General Specifications.....</b>	<b>5</b>
<b>Outline Drawing and Dimensions.....</b>	<b>6</b>
<b>Sensor Structure.....</b>	<b>7</b>
<b>Performance Measurements.....</b>	<b>8</b>
<b>Gas Sensitivity and Linearity.....</b>	<b>8</b>
<b>Tolerance to Environmental Extremes and Durability.....</b>	<b>8</b>
<b>Temperature Dependence.....</b>	<b>9</b>
<b>Response to Hydrogen.....</b>	<b>10</b>
<b>Tolerance to Temperature Transients (Heat Shock).....</b>	<b>10</b>
<b>Tolerance to Vibration.....</b>	<b>10</b>
<b>Initial Start-up time and optional Heat Cleaning Cycle.....</b>	<b>10</b>
<b>Long Term Stability, and periodic zero correction.....</b>	<b>11</b>
<b>Notes for Designers.....</b>	<b>12</b>
<b>Circuit Layout.....</b>	<b>13</b>

Note that the performance measurements expressed in this document should be considered as typical characteristics for guidance only, and not as specifications which are guaranteed, apart from those in the sections "General Specifications" and "Dimensions" (Pages 5 and 6). It is the instrument designer's responsibility to ensure that the sensor is suitable for any given application.



## **Introduction and General Description**

The NAP-78SR2 Gas Sensor from Nemoto is designed to continuously monitor the flue gases generated by gas or oil fired domestic hot water and central heating boilers in order to ensure the safety of the device and also to limit the environmental impact of the boiler under fault conditions.

The sensor will detect the presence of high levels of carbon monoxide and/or hydrogen in the flue gases generated by the boiler. High levels of these gases in the flue during normal operation occur as a result of incomplete combustion, and hence indicate a faulty boiler which could pose a safety hazard within the dwelling in which it is fitted. The signal from the sensor can be used either to trigger an alarm, or to automatically turn the boiler off to ensure the safety and well-being of the people within the building.

The NAP-78SR2 is particularly useful as an indicator of a blocked or partially blocked flue, whether in the flues air intake or in its exhaust stage. Recent changes in standards relating to domestic water heating boilers, particularly the European Standard EN 483, have highlighted the necessity of accurately detecting this fault condition, and the NAP-78SR2 sensor accomplishes this with ease, ensuring compliance with this section of the standard.

The sensor uses the well proven Catalyzed Pelletized resistor (Pellistor) method, which is well established for the detection of Flammable gases in general ambient safety applications. In the case of the NAP-78SR2 the device is specially modified, including a special resistor matrix mounted in a separate box, to give stable and reliable performance when mounted inside a boiler flue working at high temperatures.

The NAP-78SR2 sensor is well proven as a reliable real time warning of unsafe combustion conditions within boilers, and all the specifications and performance data in this manual are designed with this primary application in mind. However, note that the NAP-78SR2 sensor can also be used in a wide variety of other applications where the monitoring of flammable / explosive gases is required within ductwork or flue stacks at high temperature.

## **Principles of Operation:**

Catalytic combustion has been the most widely used method of detecting flammable gases in Industry since the invention of the catalysed pelletized resistor (or "Pellistor") over 40 years ago.

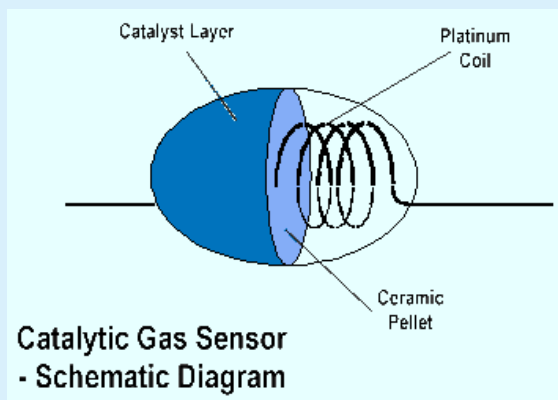

A pellistor consists of a very fine coil of platinum wire, embedded within a ceramic pellet. On the surface of the pellet is a layer of a high surface area noble metal, which, when hot, acts as a catalyst to promote exothermic oxidation of flammable gases. In operation, the pellet and so the catalyst layer is heated by passing a current through the underlying coil. In the presence of a flammable gas or vapour, the hot catalyst allows oxidation to occur in a similar chemical reaction to combustion. Just as in combustion, the reaction releases heat, which causes the temperature of the catalyst together with its underlying pellet and coil to rise. This rise in temperature results in a change in the electrical resistance of the coil, and it is this change in electrical resistance which constitutes the signal from the sensor.



Pellistors are always manufactured in pairs, the active catalysed element being supplied with an electrically matched element which contains no catalyst and is treated to ensure no flammable gas will oxidise on its surface. This "compensator" element is used as a reference resistance to which the sensor's signal is compared, to remove the effects of environmental factors other than the presence of a flammable gas.

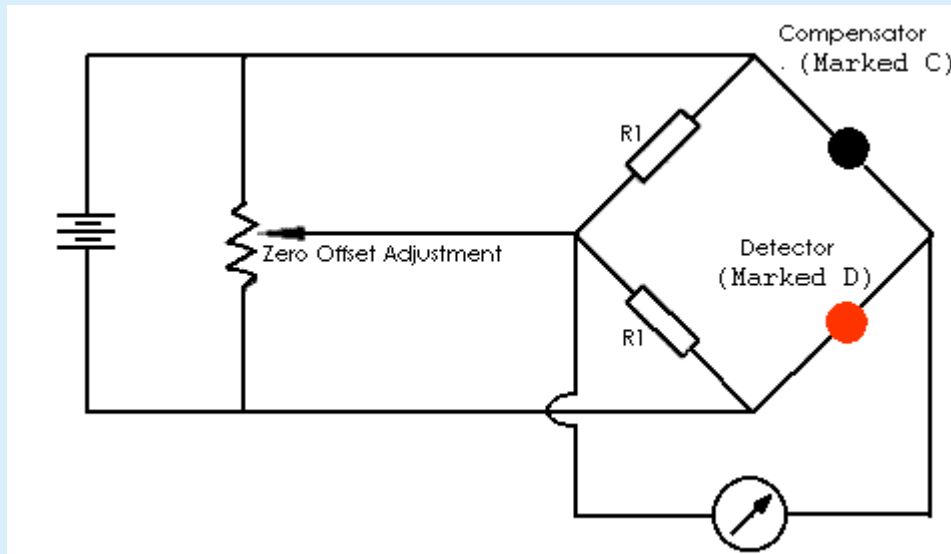

### **Pellistor Drive/Masurement Circuit: A simple Wheatstone Bridge to compare the resistance of two hot elements**

The advantage of using this technique when detecting flammable gases for safety purposes is that it measures flammability directly.

Nemoto provides matched pair pellistors conveniently mounted in a variety of enclosures for different applications. Some of these options contain the detector and compensator elements in separate enclosures (the NP range for Industrial safety applications). In the case of the NAP-78SR2, both elements are contained within a special heat resistant enclosure for ease of use and low cost, whilst the external circuit is supplied on-board the device. The circuit is modified slightly from the diagram above to ensure stable and repeatable performance across the very wide range of temperatures required for this application.

Catalytic pellistor type gas sensors have many advantages to semiconductor type gas sensors

- ❖ Linear output in proportion to gas concentration
- ❖ Greater Stability
- ❖ Higher reproducibility
- ❖ Gas specific - will only respond to flammable gases
- ❖ Unaffected by humidity
- ❖ Stable output for long periods
- ❖ More resistant to shocks and vibrations.



## General Specifications:

<b>Operating Specifications:</b>	
Detected Gases	Carbon Monoxide and Hydrogen within boiler flue gas streams
Standard Concentration Range	0-2% Carbon Monoxide (0-20,000ppm)
Recommended Bridge Voltage	2.0V +/- 0.1V
Current Consumption (at Recommended Bridge Voltage)	130-150 mA @ 2V Bridge Voltage
Bridge zero offset (Measured at 23° C)	+10mV +/- 2mV
Zero shift between 23° C and 200° C	< +/- 2mV
Typical Output Sensitivity (For a Gas Mixture of 1000ppm CO / 500ppm H <sub>2</sub> )	At 23° C:      6mV      +/- 1mV At 160° C      4.8mV      +/- 0.8mV
Linearity	Effectively Linear to 2% CO
Response Time (Measured as T <sub>90</sub> for a step change from Air to 1000ppm CO / 500ppm H <sub>2</sub> )	<60 seconds
Accuracy (Measured as Repeatability)	± 0.5mV for Zero ± 0.5mV for Gas Sensitivity
Long Term Stability Drift	Zero:            Less than +/- 2mV per year Sensitivity:      Less than +/- 2mV per Month
Expected Lifetime in the field	Over 10 Years.
<b>Environmental Specifications:</b>	
Temperature Range (Parts Mounted Inside the Flue Duct)	-25°C to +200°C (Maximum 260°C)
Temperature Range (Parts Mounted Outside the Flue Duct)	-25°C to +150°C
Standard Constant Humidity Range	0 to 99%RH
Standard Constant Pressure Range	1atm ± 10%
Recommended storage Temperature Range	0 to 20 degree C
Recommended Maximum Flow rate (Wind Velocity)	1 m/sec
Recommended Maximum Storage Time	6 months
<b>Mechanical Data</b>	
Sensor Enclosure Material	304 SS
Connector Pin Material	Nickel
Base Header Material	Heat Resistant Phenolic Resin
Protective Mesh Material	316 SS
Weight	24g



## Dimensions and Structure:

### Dimensions:

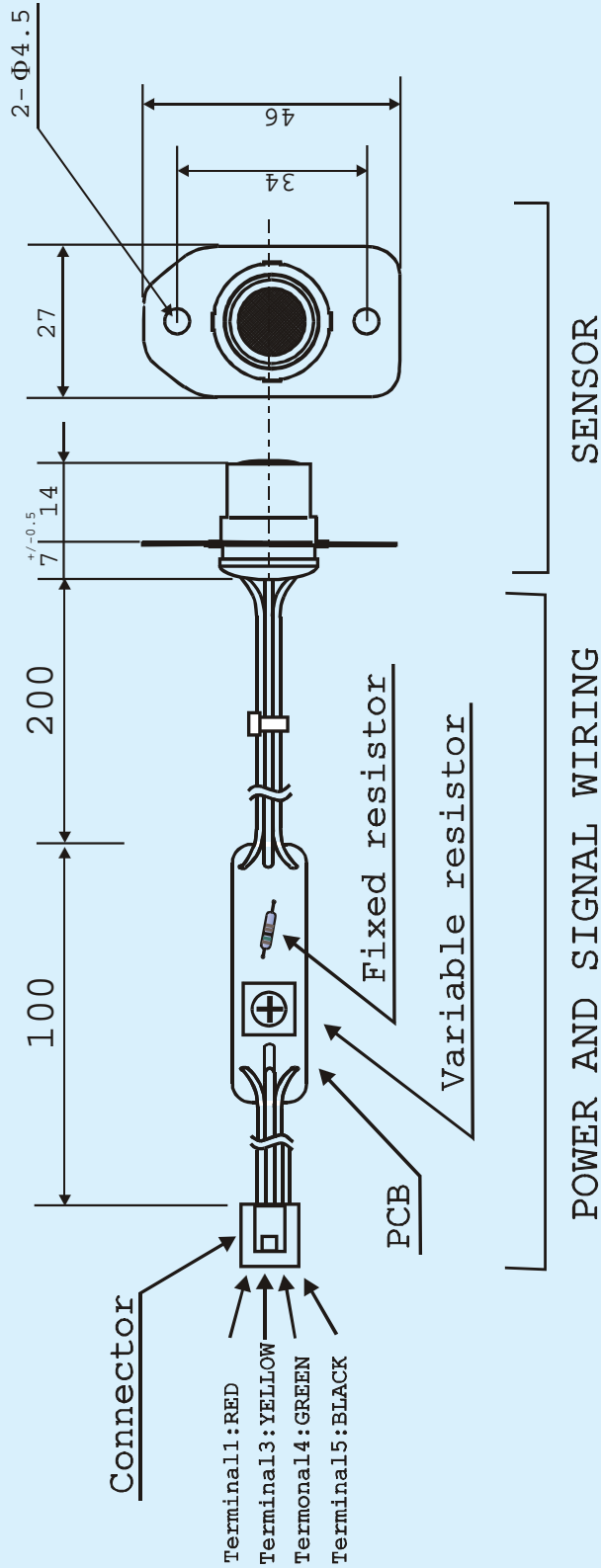

Power and signal wiring	Heat resistance 200 °C UL3533
Chip resistor for bridge circuit	510Ω +/-1%
Fixed resistor	+/-1%
Variable resistor	NIDEC COPAL ELECTRONICS CORP. FT-6
PCB	Outline dimensions : 37 X 10 UL94-0
Connector	Housings N-1020-9205 Receptacles 172032-M2 (NIPPON TANSHI.)



## Sensor Structure:

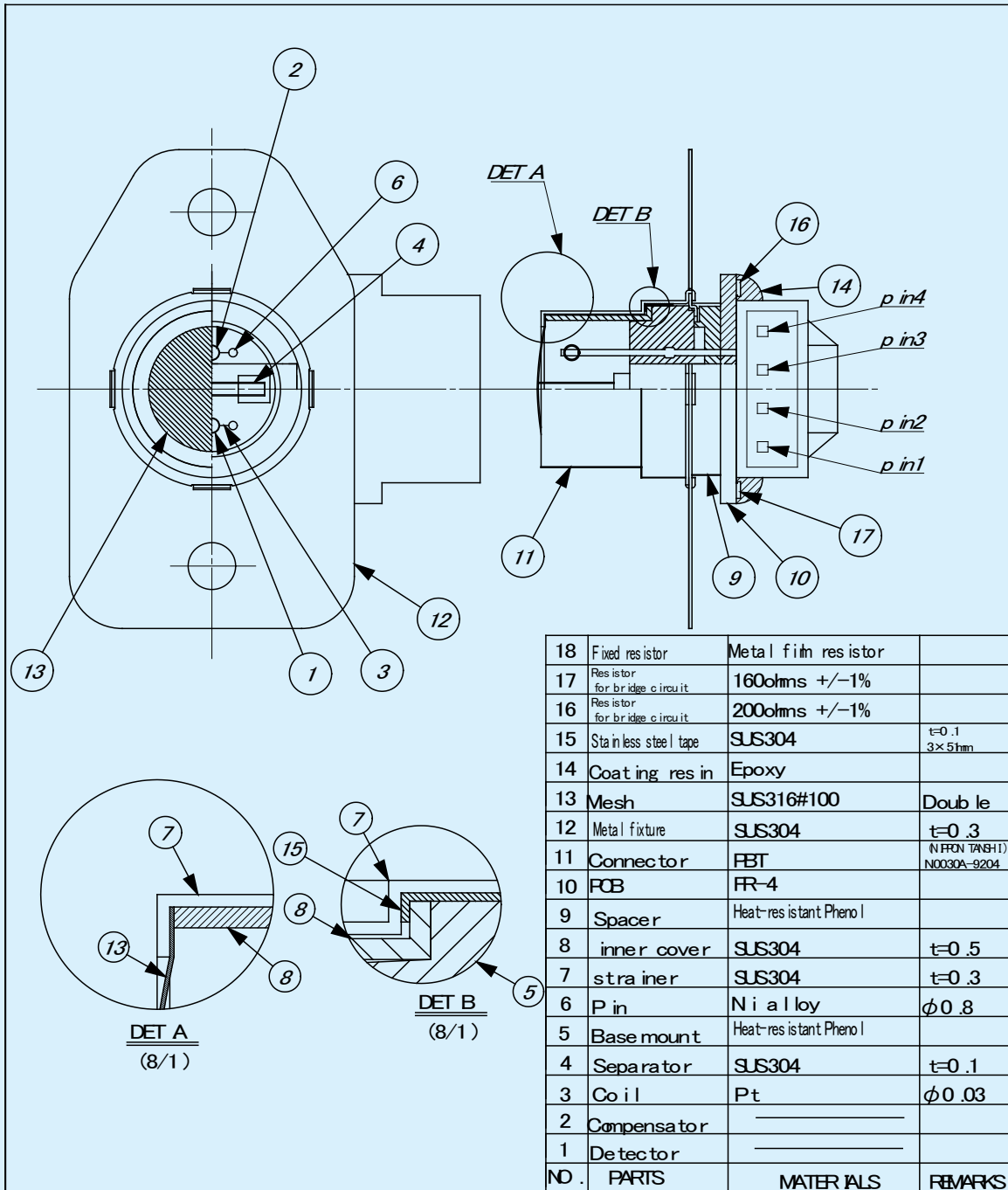

18	Fixed resistor	Metal film resistor	
17	Resistor for bridge circuit	160ohms +/-1%	
16	Resistor for bridge circuit	200ohms +/-1%	
15	Stainless steel tape	SUS304	t=0.1 3x5mm
14	Coating resin	Epoxy	
13	Mesh	SUS316#100	Double
12	Metal fixture	SUS304	t=0.3
11	Connector	FBT	(NIPPON TANGHT) N0030A-9204
10	PCB	FR-4	
9	Spacer	Heat-resistant Phenol	
8	inner cover	SUS304	t=0.5
7	strainer	SUS304	t=0.3
6	Pin	Ni alloy	φ0.8
5	Base mount	Heat-resistant Phenol	
4	Separator	SUS304	t=0.1
3	Coil	Pt	φ0.03
2	Compensator		
1	Detector		
NO.	PARTS	MATERIALS	REMARKS



## Results of Performance Tests

The information contained in this section is for guidance purposes only and should not be considered to be part of the specification of the NAP-78SR2 Gas Sensor for legal or warranty purposes.

### Gas Sensitivity and Linearity (Measured at room temperature)

The following graph illustrates the sensitivity to a 2:1 mixture of Carbon Monoxide and Hydrogen:

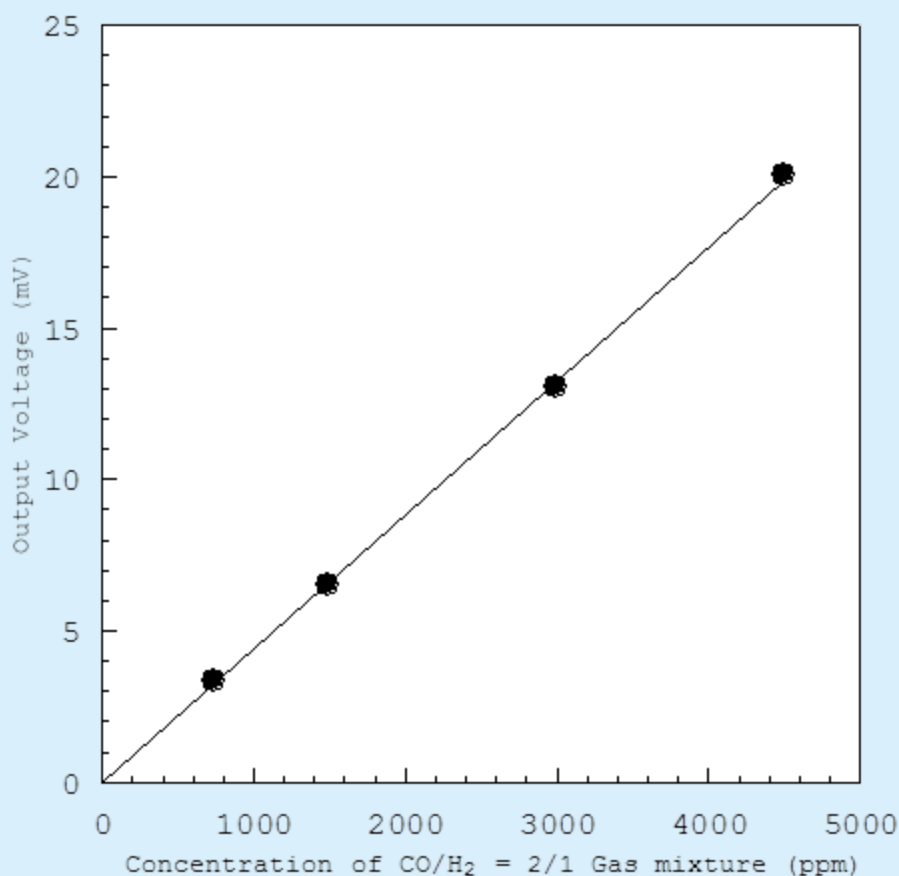

### Durability

The NAP-78SR2 sensor has been designed and tested vigorously to ensure that it can tolerate a range of arduous conditions:

**Storage in low temperature:** Sensors have been stored at temperatures of -30°C for 1 month.

**Storage in high temperature:** Sensors have been stored at temperatures of +80°C for 1 month.

**Tolerance to High Humidity:** Sensors have been stored in 50°C and 98%RH for 48 hours.

**Prolonged Storage Time:** Sensors have been stored for 6 months in normal ambient conditions.





**Catalyst Poison Resistance:** Sensors have been exposed to 10ppm Hexamethyldisiloxane (HMDS), a commonly encountered silicone which is known to poison noble metal catalysts.

After all of the above environmental conditions, the NAP-78SR2 was tested for Span and Sensitivity. In all cases the sensors showed the following results:

Gas Concentration	Working Temperature	Result following Environmental Test
0 ppm (Air)	23°C	Initial Value +/- 1.5mV
	100°C	Value at 23°C +/- 1mV
	200°C	Value at 23°C +/- 1mV
1000ppm CO / 500ppm H <sub>2</sub>	23°C	Initial Value +/- 0.7mV
	140°C	Initial Value +/- 0.5mV

### Temperature Dependence

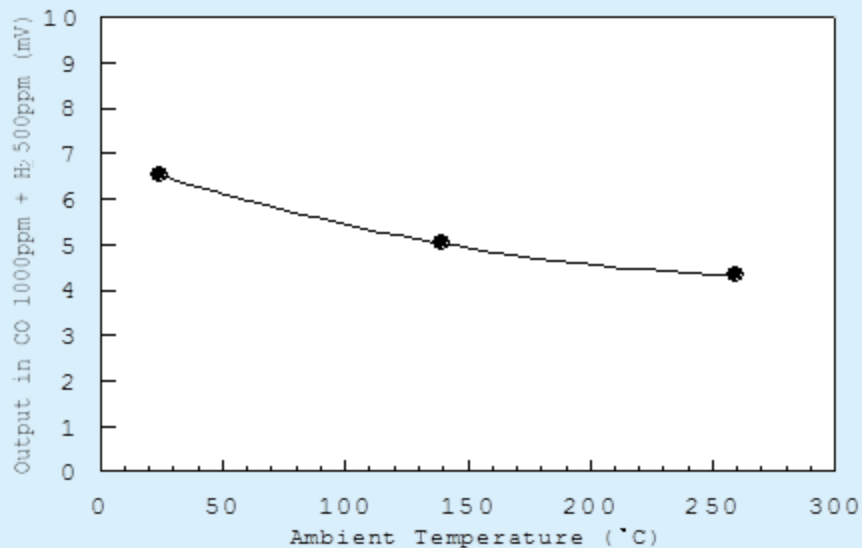
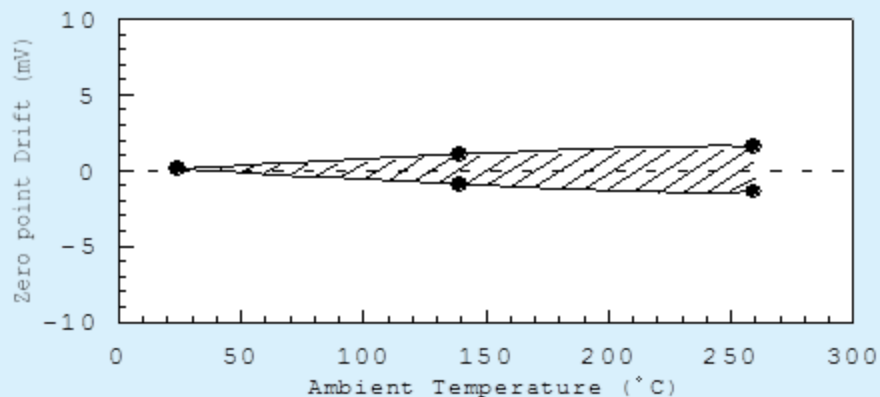



## **Response to Hydrogen:**

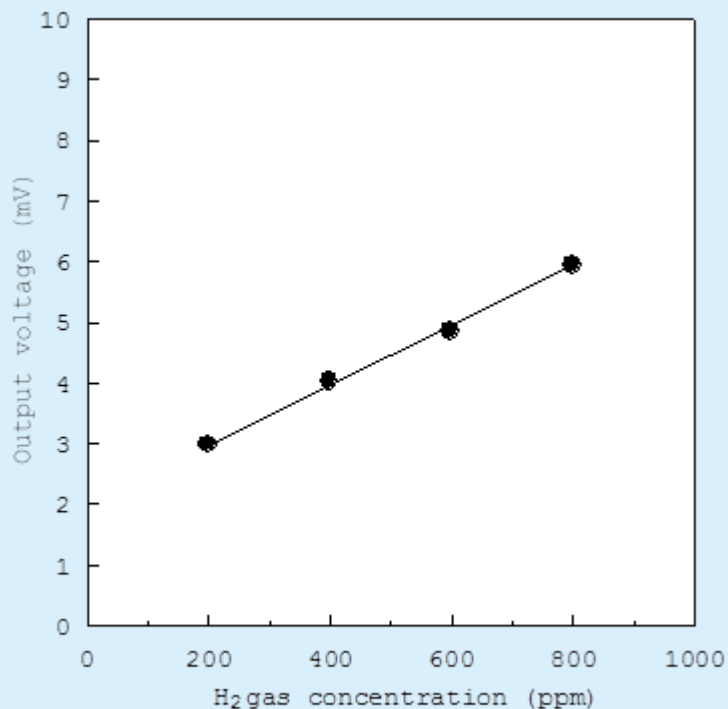

### Composition Balance gas:

CO 1000ppm  
H<sub>2</sub>O 12%  
CO<sub>2</sub> 7.5%  
O<sub>2</sub> 7.5%  
Remainder N<sub>2</sub>

Temperature:  
200 deg C

## **Tolerance to Temperature Transients (Heat Shock)**

Sensors have been stored at -30°C for 2 hours then suddenly transferred to an environment of 80°C degree C for 2 hours. This temperature cycle was repeated 700 times. Following the temperature cycling, all components and joints were examined very closely for signs of physical damage, including solder connections. The sensors were also tested for Zero and Gas Sensitivity. No significant effect was noted on either the structure or the performance of the sensors.

## **Tolerance to Vibration**

Sensors were subjected to a vibration of 10 Hz, Amplitude 5mm, 1G in all three planes X, Y and Z for 20 minutes. No effect on performance or structural integrity of the device was detected following the vibration.

## **Tolerance to Corrosive Gases**

Sensors have been tested thoroughly for long periods in gases containing SO<sub>2</sub> and NO<sub>2</sub> gases. No significant effect on the performance of the sensor has been noted. Nemoto is confident that, at the levels encountered in normal flue gases, these gases will have no detrimental effect to the performance of the sensor.

## **Initial Start-up time and optional Heat Cleaning Cycle**

On initial power-up, the NAP-78SR2 sensor will normally stabilize to a workable zero offset within 2 minutes. However, when powered-up for the first time following storage or a long period of inactivity, catalytic type gas sensors can sometimes take several hours to completely stabilize to their final zero offset point.

For the majority of applications the initial stabilization time, even after long periods of storage, presents no problem since the zero stability after 120 seconds is within acceptable limits. However, if very high accuracy is required immediately following initial power-up, the stabilization of the sensor can be hastened by the application of a higher power supply (2.75V is recommended) for the first 30 seconds of operation, followed by the normal operating power supply. This "Heat Cleaning Cycle" will result in the sensor reaching its final zero reading more quickly than if it had the operating voltage applied only.



The plot below illustrates the initial stabilization of sensors when powered for the first time following 30 days of normal storage.

It can be seen that by using a heat cleaning cycle the gain in initial stabilization time is very slight and for most purposes the heat cleaning option gives little benefit.

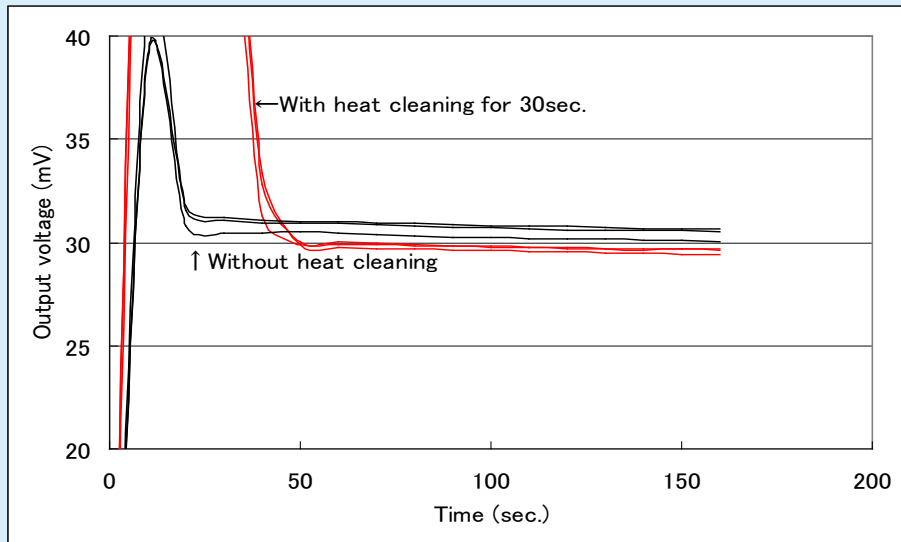

### Long Term Stability and Periodic zero correction

The following plots represent the typical long term stability of the NAP-78SR2 in a real working situation within a water heating boiler:

#### Zero Offset:

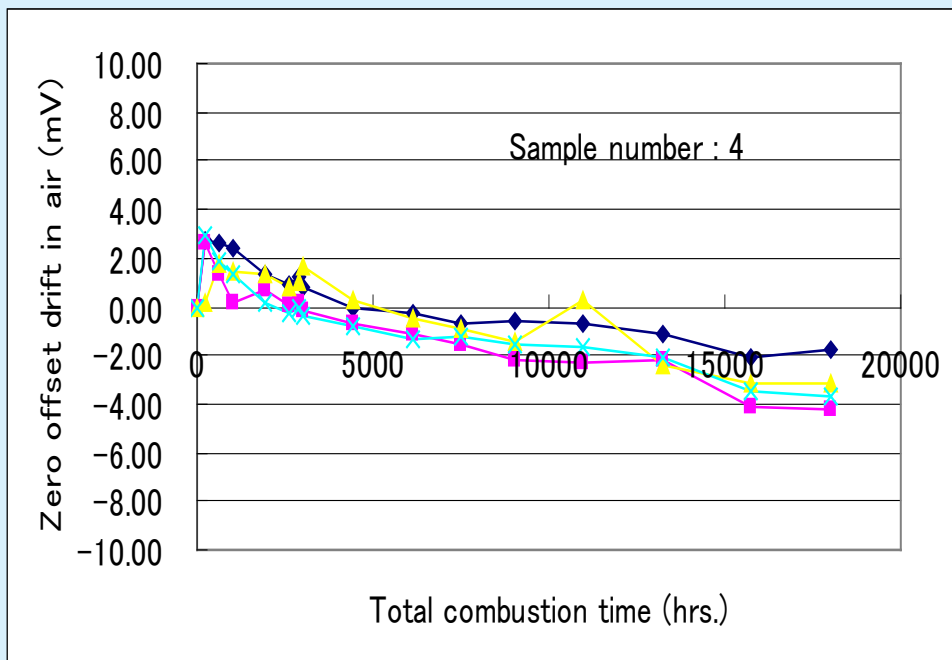



## Gas Sensitivity:

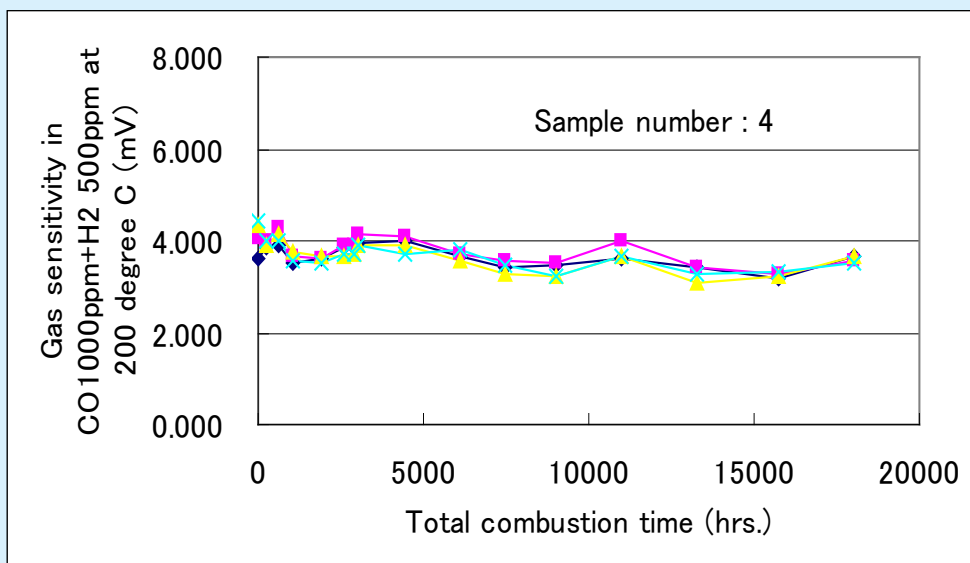

It can be seen that although the Gas Sensitivity of the sensor does not change significantly during the sensors lifetime in a real working situation, the zero offset does drift with time. However, this can easily be compensated for in the software of the appliance by carrying out a routine zero correction calibration during periods where the force ventilation of the flue is running but the burner is inactive, ensuring that no combustion gases are in the flue of the boiler during this procedure.

This zero adjustment could be carried out, for example, whenever the appliance is switched on, just before the Burner is ignited.

## Notes for Designers.

### 1) **Sensor Fault Diagnosis:**

It is recommended that the sensor is monitored for the unlikely event of an open-circuit or short circuit-fault during the lifetime of the appliance. In the case of an open-circuit fault, the zero offset signal of the sensor will change to close to either -1V or +1V

In the case of a short circuit fault, the sensor's zero offset signal will change to either 0V or 2V.

It is therefore recommended that if the zero offset voltage changes to less than 0V (i.e. a negative value) or more than 150mV, then the appliance should signal a fault and the sensor should be replaced.

### 2) **Mounting Position of the Sensor:**

The optimum position of the sensor is a matter for the appliance designer and Nemoto does not prohibit positioning of the sensor in any orientation or position within the flue, provided the sensor is operating within its environmental specification. However, it is recommended that the sensor is mounted on a vertical wall of the flue, since it is in this orientation that all Nemoto's specification tests are performed.

If necessary, the sensor should be provided with gasket seal to ensure that flue gases do not escape from the flue.

The position of the sensor should be chosen to maximise its sensitivity and response time, whilst avoiding turbulent flow of gas at the sensor during operation if possible. The sensor should also be as far away as possible from other electrical parts of the appliance to minimise interference and RF electrical noise in the sensor signal. In many cases the best mounting position of the sensor will be determined by trial and error.

### 3) To avoid the potential of damage to the sensor by undue vibration, it is recommended that the sensor is not fitted to the appliance using power driven tools.



- 4) It is recommended that the sensor is permanently energised. This means that even when the appliance is not being used, the sensor remains energised and operating normally.
- 5) Since the detection of incomplete combustion by the sensor will result in the appliance being automatically shut down, it is recommended that a time weighted average measurement is used to verify the signal from the sensor. This will eliminate the slim possibility of false alarms caused by electrical noise spikes from pumps, switches etc within the appliance.

## **Circuit Layout**

The diagram on the following page illustrates the basic circuit and mode of operation of the NAP-78SR2. All the components within the green shaded area are included on-board the device, the remainder of the circuit provided by the instrument designer / manufacturer.

“C” and “D” are the compensator and detector elements of the device.

The area marked “RESISTOR SELECT” indicates that a resistor is placed here (by Nemoto) in parallel with the Detector element or Compensator element (but not both). Occasionally no resistance may be required or fitted. The function of this resistor is to provide temperature compensation to ensure that the zero baseline at ambient temperature is the same as at the hot working temperature of the boiler. Nemoto determines the correct resistance value individually for each device, and fits the resistor accordingly.

R6 and R7 are simple balancing resistors, to balance the Wheatstone bridge.

VR1 is a variable resistance which provides a second stage zero correction. The raw zero specification of the sensor, if VR was not fitted, would be approximately as +20mV to +90mV, and VR1 is pre-adjusted by Nemoto to give a zero offset of +10mV. Nemoto may supply the NAP-78SR2 sensor with customer specified zero offset if required.

It is therefore recommended that VR1 is never adjusted.

The NAP-78SR2 is provided with a 5 pin connector, assigned as follows:

Terminal 1 (to the Red wire):	Power supply (+2V)
Terminal 5 (to the Black wire):	Power supply Ground (GND)
Terminals 3 and 4 (to the Yellow and Green wires):	The mV signal from the sensor.
Terminal 2 is not used.	

**Note that the signal –ve connection must not be connected to GND. The power and signal connections must remain isolated.**

