

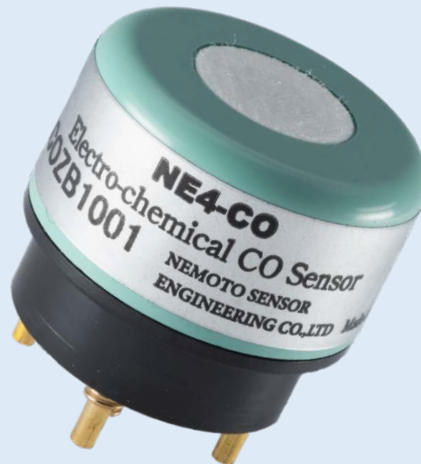

**Nemoto Sensor
Engineering
Company Ltd**

4-10-9 Takaido-Higashi
Suginami-ku
Tokyo 168-0072
Japan

Web: www.nemoto.eu
E-mail: sensor2@nemoto.co.jp



Technical Information and User Manual

NE4-CO Electrochemical Carbon Monoxide (CO) Gas Sensor

For Industrial Applications

Apart from pages 4 and 5 (Specification and Dimensions sections), the data in this document does not constitute a specification but is intended as a guide, informing the instrument designer of the performance characteristics of the sensor which were observed by Nemoto Sensor Engineering scientists.

It should be read in conjunction with the official datasheet for the device, which includes the full technical specification for the NE4-CO Gas Sensor.

Nemoto Sensor Engineering Co. Ltd. has a policy of continuous development and improvement of its products. As such the specification and data outlined in this document may be changed without notice



INTRODUCTION

Nemoto & Co. Ltd was established in 1941 and continues to develop unique technologies for Safety, Security and Health markets worldwide. Using our unique experience of fine chemical preparation and printing, we were able to enter the gas sensor market in 1979 with a range of high-quality hot-wire type sensors (pellistors). Nemoto is now one of the world's leading manufacturers of chemical sensors and has so far delivered over 30-million devices to the market.

As a result of three years' development at our Tokyo R&D centre, we released our first electrochemical gas sensor in 2000.

The NE4-CO Gas Sensor is a 3-Electrode electrochemical gas sensor designed for the detection and measurement of carbon monoxide in the range 0-1000ppm, in a wide range of industrial and commercial safety applications. By adhering to industry standards for size and connection orientation, the NE4-CO can be retrofitted easily to existing product designs.

By using our experience of design for manufacture and our high volume production facilities in Japan and China, we have successfully reduced the cost of the NE4-CO whilst being able to maintain the highest performance quality.

PRINCIPLES OF OPERATION

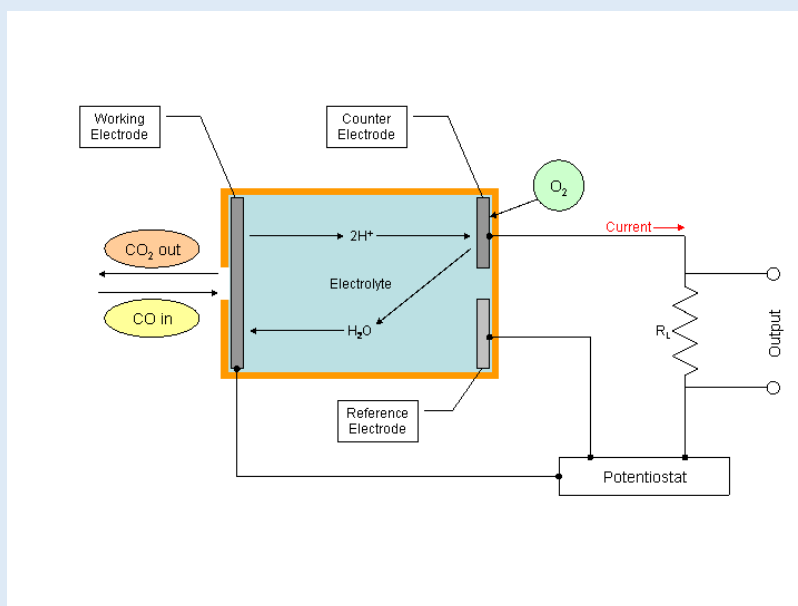

The NE4-CO consists of 3 porous noble metal electrodes separated by an acidic aqueous electrolyte, housed within a plastic (PPO) enclosure. Gas enters the cell via a gas phase diffusion barrier (capillary) and a charcoal based filter that removes unwanted gases which might interfere with the sensors performance or give a false signal. An electrolyte reservoir ensures an excess of electrolyte is available at all times, and the sensor is vented to ensure that the internal and external pressure of the sensor is always in equilibrium.

In operation, gas enters the cell via the capillary and filter, and comes into contact with the 'working' electrode. Any carbon monoxide present undergoes the following (oxidation) reaction:

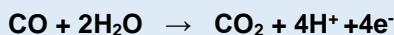



The CO₂ generated vents away from the cell via the capillary, whilst the hydrogen ions (H⁺) migrate into the electrolyte within the cell. The electrons (e⁻) generated at the working electrode are collected by the external circuit via a metal strip in contact with it, in the form of a small (nA) electric current.

The reaction at the working electrode is balanced by a reciprocal (reduction) reaction at the 'counter' electrode, using Oxygen from the surrounding atmosphere.

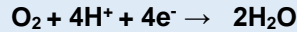

The electrons consumed in this reaction are supplied by the external circuit via a metal strip in contact with the counter electrode.

Thus water is consumed whilst Hydrogen ions are generated at the working electrode, whilst the water is re-created and hydrogen ions are consumed at the counter electrode. At the same time, the reaction at the working electrode generates electrons, whilst the reaction at the counter electrode consumes electrons. By connecting the working and counter electrodes together via a special circuit, the flow of electrons between the two electrodes may be measured as a nA level current signal proportional to the ppm concentration of carbon monoxide.

The 'reference' electrode maintains the healthy operation of the cell. It is surrounded by electrolyte, sees no gas and no current is allowed to be drawn from it. Its electrochemical potential hence always remains constant at a level known as the "rest air potential" and this is used to regulate the potential of the working electrode, regardless of the current it is generating during operation. The use of a reference electrode in this way (i.e. three-electrode operation) helps to extend the working range of the sensor, improves linearity and results in a number of performance benefits compared with similar sensors working with 2-electrodes only.

FEATURES

Electrochemical gas sensors have the following superiority to conventional semiconductor type and hot-wire type gas sensors.

- **Linear output in proportion to gas concentration**
- **High reproducibility**
- **Highly gas specific**
- **Unaffected by humidity**
- **Stable output for long periods**
- **Low power consumption because no heater is used (can be battery operated)**
- **Small and lightweight (can be used in portable devices)**
- **No mechanical structure so highly resistant to shocks and vibrations.**

The NE4-CO has been developed from our accumulation of technologies in production of hot-wire type gas sensors, long research experience into catalysts, fine printing, and assembling of sensors. The NE4-CO is small and less-expensive, but has high sensitivity, long life, and leak-free performance even under severe operating conditions.

Air vent

The electrolyte used for chemical sensors is very hygroscopic, i.e. it has affinity for water, and its volume varies depending on ambient temperature and humidity. This variation causes pressure inside the sensor to rise and fall. In the worst case, the electrolyte may leak out of the sensor and damage the circuitry around it.

To prevent this, the NE4-CO utilizes an air vent capability. This maintains equilibrium between internal and external pressures and allows the sensor to be used in any orientation and under high temperature and humidity conditions.



SPECIFICATIONS:

Output signal		70 +/- 15nA/ppm CO
Zero offset in clean air		< +/- 5ppm equivalent
Response time (T90)	(T ₉₀)	< 30sec.
Repeatability	(Same day measurement)	< +/- 2%
Long Term Stability	Zero offset	< +/-5ppm equivalent / year
	Sensitivity to CO	< +/- 5% signal / year
Temperature dependence	(Zero offset swing)	< +/-10ppm (-20°C to +50°C)
Temperature range	In Service	-20°C to +50°C
	Recommended in Storage	-0°C to +20°C
Humidity range	In Service	15 – 90%RH (non-condensing)
	Recommended in Storage	15 – 90%RH (non-condensing)
Pressure range in service		0.9 – 1.1 atm
Detection range		0 - 1000ppm
	Maximum Overload Range	2000ppm
Recommended load resistor		10Ω
Recommended maximum storage time		6 months
Warranty	Against faulty workmanship or materials	24 months



DIMENSIONS:

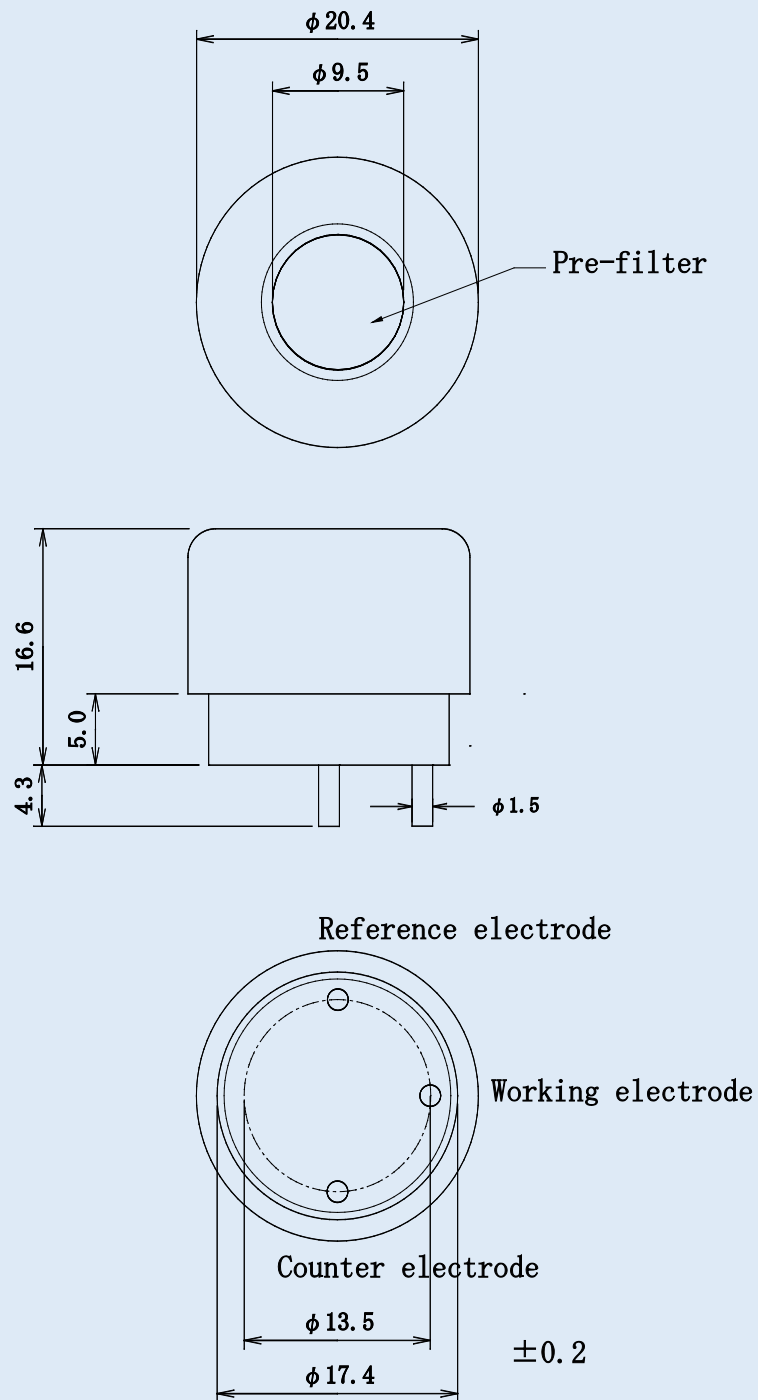

Case Material	PPO
Cap Color	Light Green
Weight	5 g (approx.)



PERFORMANCE DATA

1) Linearity

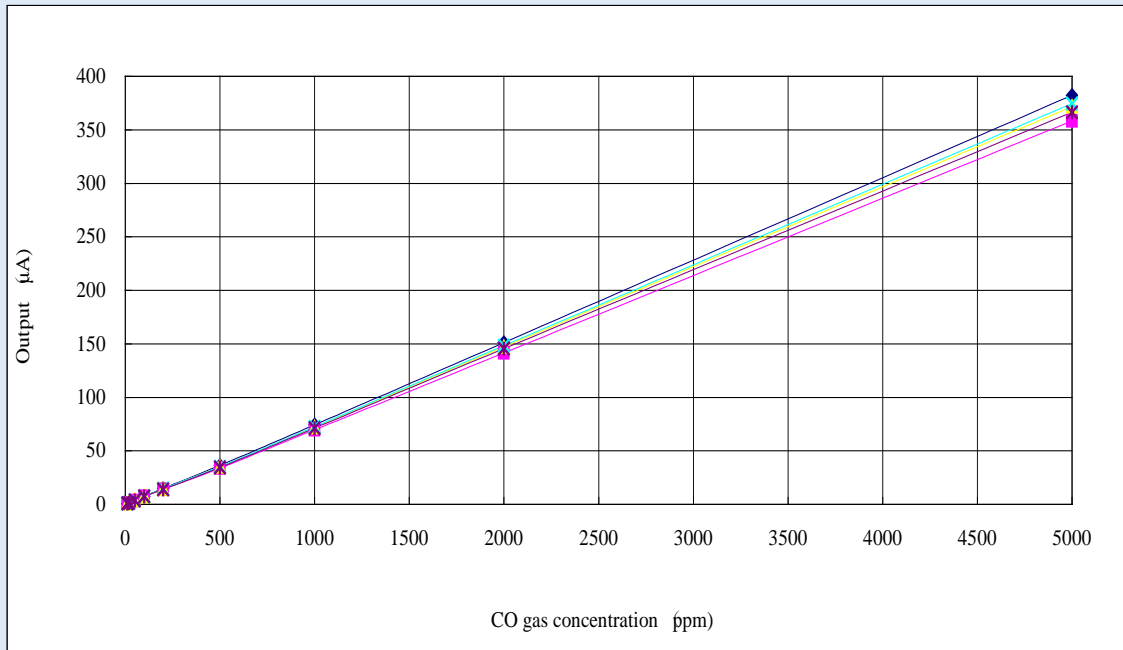

2) Uncompensated Temperature Dependence:

The following graph illustrates the typical effect of temperature on the output signal of the NE4-CO, for a sensor calibrated at 20°C:

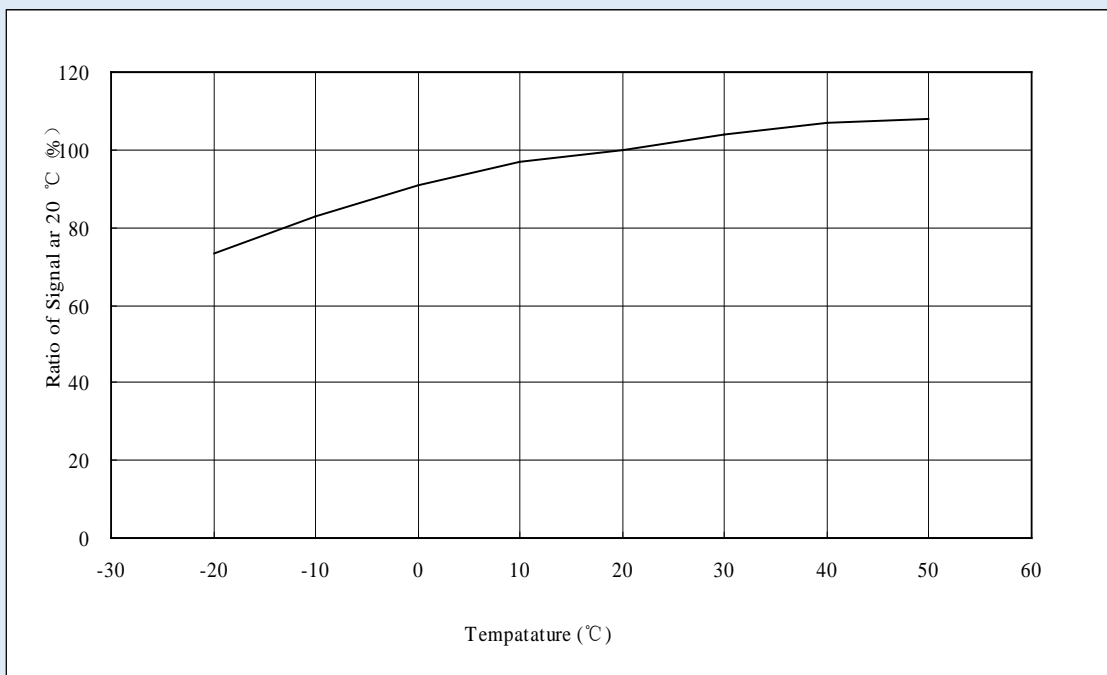



The following graph illustrates the typical effect of temperature on the zero offset of the NE4-CO, with 2 standard deviation confidence limits

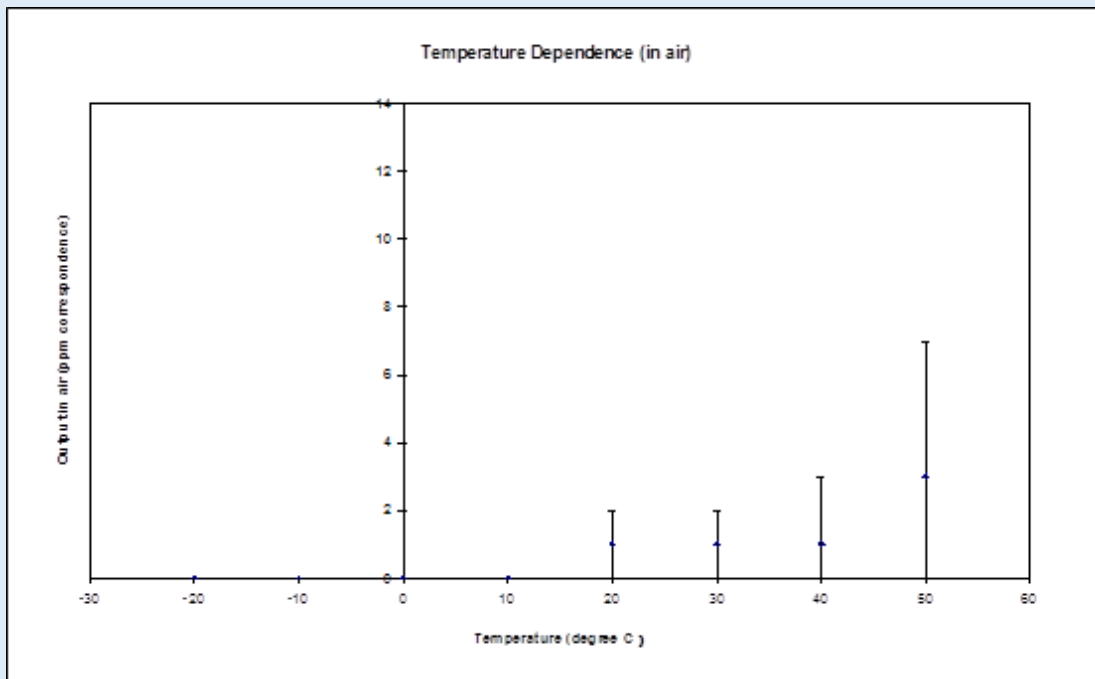

3) Cross Sensitivities:

The following table gives cross sensitivity information for a variety of commonly encountered gases.

Test Gas	Tested Concentration (ppm)	CO equivalent reading (ppm)	% cross-sensitivity
Carbon monoxide	100	100	100
Hydrogen Sulphide	10	0	0
Hydrogen	1000	<400	<40
Methane	5000	0	0
Carbon dioxide	5000	0	0
Sulphur dioxide	30	0	0
Nitric oxide	50	<35	<70
Nitrogen dioxide	30	<2	<7
Ammonia	1000	0	0
Ethyl acetate	200	0	0
Ethanol	2000	<20	<1
Ethylene	100	<80	<80
Chlorine	1	0	0
Formic Acid	100	0	0



4) Response Characteristics

The following are plots of typical responses and recovery times for exposures to carbon monoxide at various concentrations:

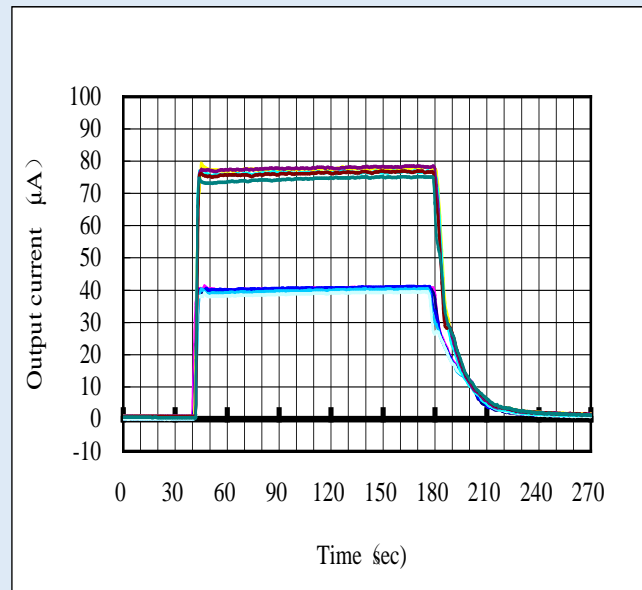
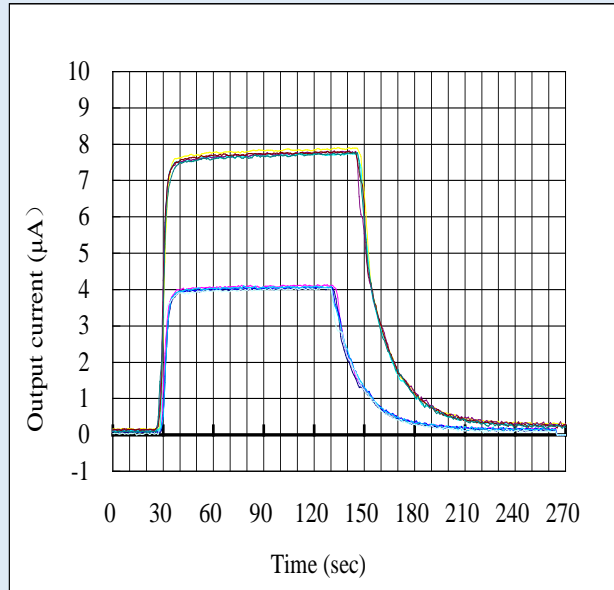

5) Long-Term Drift Characteristics:

The following graph illustrates the typical Long-term sensitivity stability of the NE4-CO sensor over 700 days of operation.

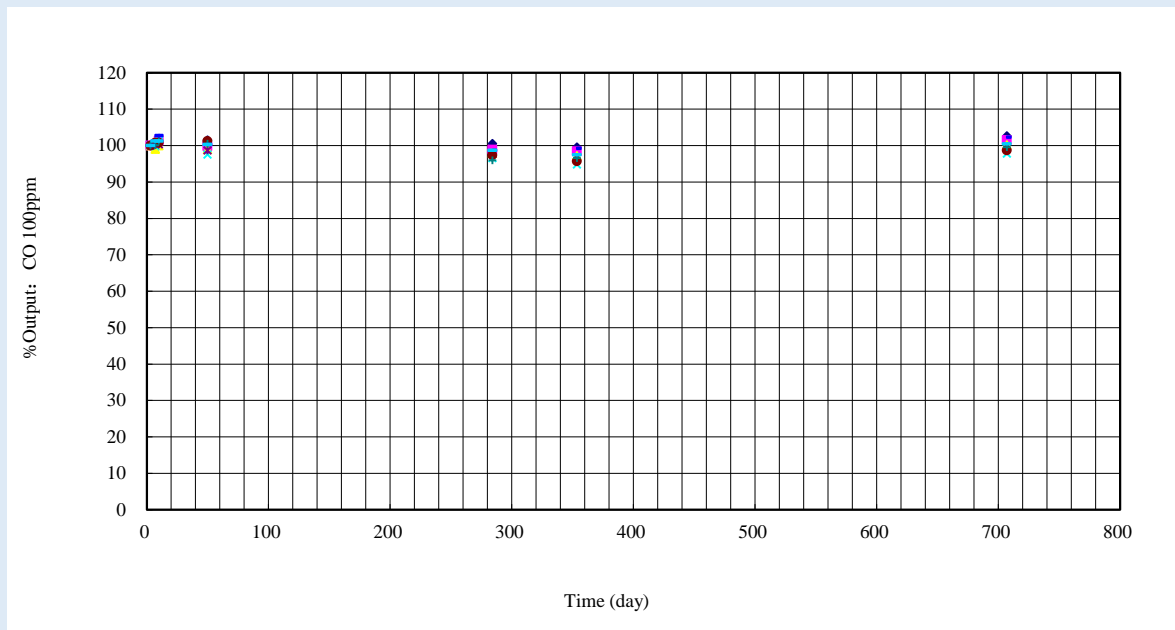

This data was generated in bench tests in a controlled clean environment. In service, in a real application, the long-term stability will also be dependent on the environmental conditions of the application.



TOLERANCE TO ENVIRONMENTAL EXTREMES

1) Tolerance to temperature extremes

The following graph illustrates the signal output stability for a sensor exposed to +50°C at 90%RH over 1000 hours. The Co concentration used was 100ppm CO in air.

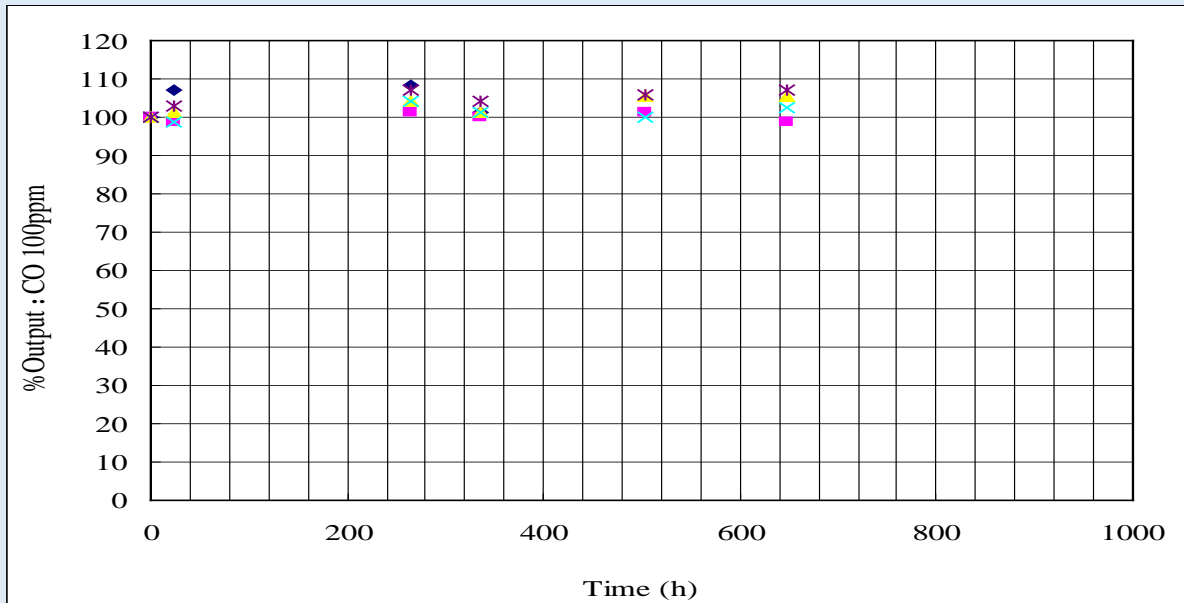

The following graph illustrates the signal output stability for a sensor exposed to +50°C in dry (0% RH) over 1200 hours. The CO concentration used was 100ppm CO in air.

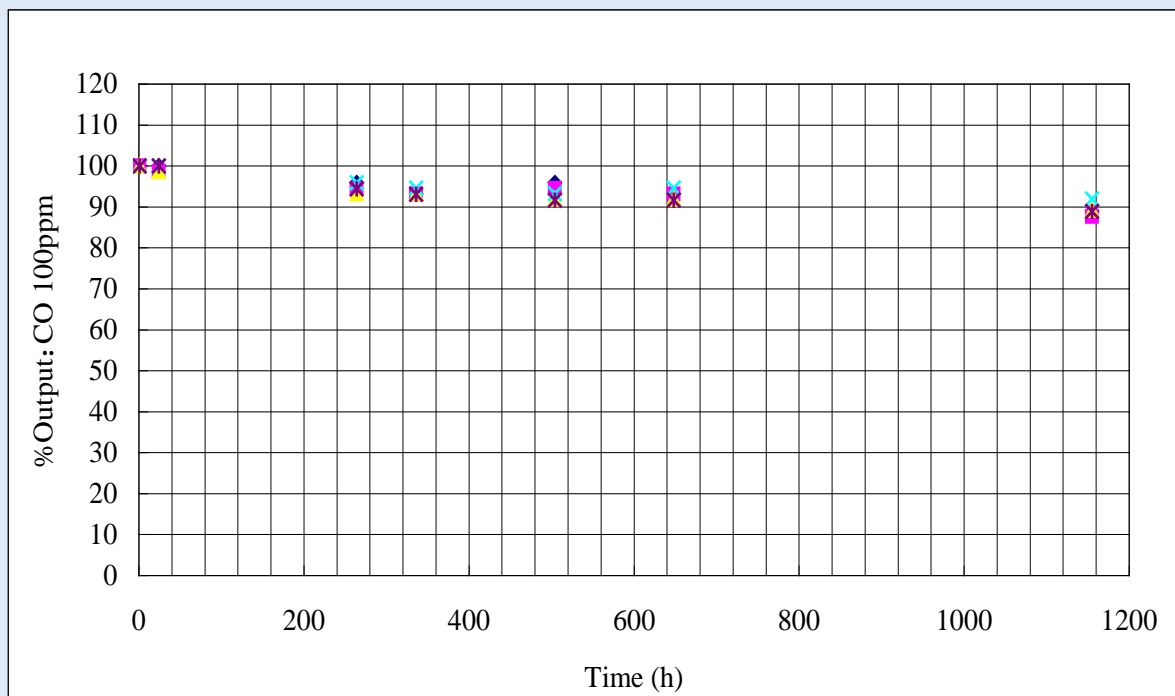



The following graph illustrates the signal output stability for a sensor exposed to -20°C over 1200 hours. The CO concentration used was 100ppm CO in air.

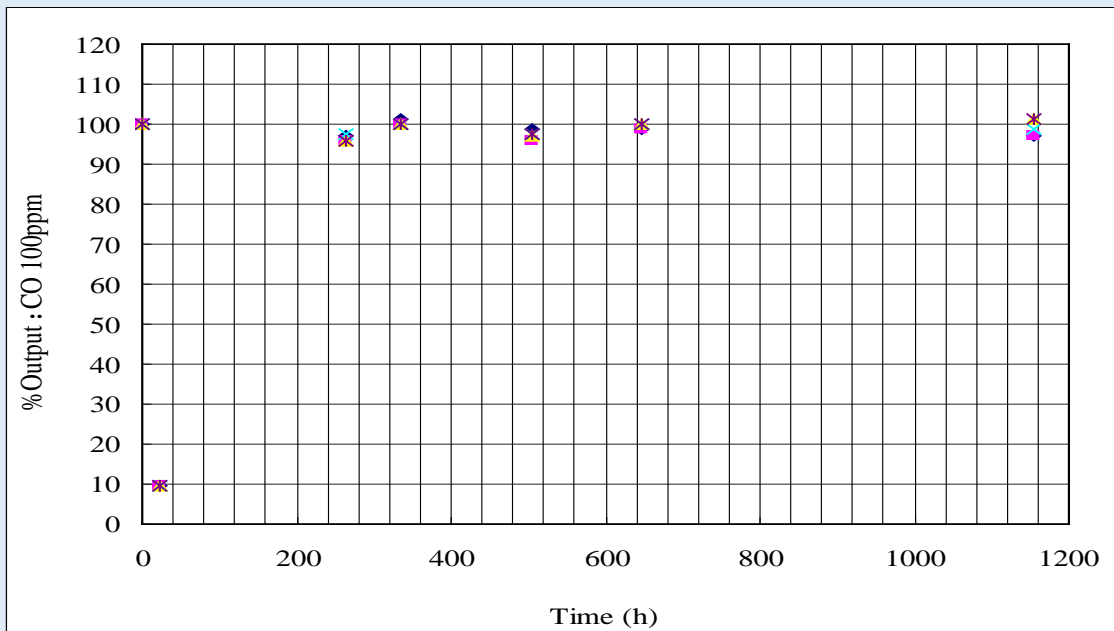

2) Tolerance to Overrange levels of Carbon Monoxide:

The following table shows the zero and sensitivity change following an exposure to 3000ppm CO for 20 hours, at 25°C and 50% RH. The gas concentration used for testing was 100ppm.

No.	Before exposure		After exposure		Sensitivity variation ratio (%)
	Zero offset in air (µA)	Sensitivity to 100ppm CO (µA)	Zero offset in air (µA)	Sensitivity to 100ppm CO (µA)	
1	0.06	7.17	-0.02	7.19	100.3
2	0.06	7.27	-0.01	7.30	100.4
3	0.07	7.36	-0.01	7.27	98.8
4	0.09	7.71	0.01	7.80	101.2
5	0.19	7.92	0.02	7.81	98.6

3) Tolerance to thermal shock

The following table shows the zero and sensitivity change following an exposure to -20°C for 30 minutes, followed immediately with an exposure to +50°C for 30 minutes. This 60 minutes cycle was repeated 10 times. The gas concentration used for testing was 100ppm.

No.	Before temperature cycling		After temperature cycling		Sensitivity variation ratio (%)
	Zero offset in air (µA)	Sensitivity to 100ppm CO (µA)	Zero offset in air (µA)	Sensitivity to 100ppm CO (µA)	
1	-0.25	7.82	-0.26	7.80	99.7
2	-0.29	7.34	0.30	7.44	101.4
3	-0.21	7.22	-0.22	7.28	100.8
4	-0.30	7.10	0.21	7.16	100.8
5	-0.15	7.33	0.16	7.42	101.2



4) Tolerance to mechanical shock

The following table shows the zero and sensitivity change following a drop test: The sensor was dropped from a height of 1m on to a concrete floor 5 times. The gas concentration used for testing was 100ppm.

No.	Before test (micro A)		After test (micro A)		Sensitivity variation ratio (%)
	Zero offset in air (μ A)	Sensitivity to 100ppm CO (μ A)	Zero offset in air (μ A)	Sensitivity to 100ppm CO (μ A)	
1	0.18	7.37	0.18	7.37	100.0
2	0.22	7.63	0.26	7.59	99.5
3	0.19	7.45	0.24	7.40	99.4
4	0.21	7.81	0.12	7.90	101.2
5	0.22	7.68	0.31	7.59	98.8

5) Tolerance to Sulphur Dioxide (SO₂)

The following table shows the zero and sensitivity change following an exposure to 500ppm Sulphur Dioxide (SO₂) for 30 minutes. The gas concentration used for testing was 100ppm.

No.	Before exposure		After exposure		Sensitivity variation ratio (%)
	Zero offset in air (μ A)	Sensitivity to 100ppm CO (μ A)	Zero offset in air (μ A)	Sensitivity to 100ppm CO (μ A)	
1	0.18	8.02	0.19	8.06	100.5
2	0.12	7.75	0.17	7.71	99.4
3	-0.06	7.50	0.03	7.58	101.1
4	0.06	7.90	0.13	7.84	99.3
5	0.22	7.39	0.31	7.36	99.6

6) Tolerance to Ethanol vapour

The following table shows the zero and sensitivity change following an exposure to 2000ppm Ethanol for 30 minutes. The gas concentration used for testing was 100ppm.

No.	Before exposure		After exposure		Sensitivity variation ratio (%)
	Zero offset in air (μ A)	Sensitivity to 100ppm CO (μ A)	Zero offset in air (μ A)	Sensitivity to 100ppm CO (μ A)	
1	0.16	8.10	0.25	8.02	99.0
2	0.14	7.76	0.30	7.80	100.5
3	0.02	7.51	0.29	7.46	99.3
4	0.12	7.89	0.30	8.04	101.9
5	0.29	7.35	0.31	7.53	102.4



7) Tolerance to Nitrogen Dioxide (NO₂)

The following table shows the zero and sensitivity change following an exposure to 800ppm Nitrogen Dioxide (NO₂) for 30 minutes. The gas concentration used for testing was 100ppm.

No.	Before exposure		After exposure		Sensitivity variation ratio (%)
	Zero offset in air (µA)	Sensitivity to 100ppm CO (µA)	Zero offset in air (µA)	Sensitivity to 100ppm CO (µA)	
1	0.26	8.05	0.14	7.90	98.1
2	0.24	7.95	0.15	7.85	98.7
3	0.25	7.98	0.16	7.86	98.4
4	0.22	7.83	0.14	7.78	99.4
5	0.20	7.89	0.14	7.87	99.7

8) Tolerance to Acetone vapour

The following table shows the zero and sensitivity change following an exposure to 1500ppm Acetone vapour for 60 minutes. The gas concentration used for testing was 100ppm.

No.	Before exposure		After exposure		Sensitivity variation ratio (%)
	Zero offset in air (µA)	Sensitivity to 100ppm CO (µA)	Zero offset in air (µA)	Sensitivity to 100ppm CO (µA)	
1	0.09	8.08	0.26	8.01	99.0
2	0.06	7.95	0.28	7.90	99.5
3	0.07	7.96	0.22	7.90	99.2
4	0.06	7.81	0.17	7.76	99.4
5	0.04	7.95	0.18	7.88	99.1

9) Tolerance to Silicone vapours

The following table shows the zero and sensitivity change following an exposure to 100ppm HMDS (HexaMethylDiSiloxane) vapour for 60 minutes. The gas concentration used for testing was 100ppm.

No.	Before exposure		After exposure		Sensitivity variation ratio (%)
	Zero offset in air (µA)	Sensitivity to 100ppm CO (µA)	Zero offset in air (µA)	Sensitivity to 100ppm CO (µA)	
1	0.32	8.13	0.33	8.07	99.3
2	0.31	8.07	0.34	7.72	95.6
3	0.29	8.08	0.32	7.92	98.0
4	0.26	7.92	0.34	7.81	98.6
5	0.25	8.02	0.34	7.83	97.6



NOTES FOR CIRCUIT DESIGN

The basic measuring circuit for all 3-electrode electrochemical gas sensors is shown below:

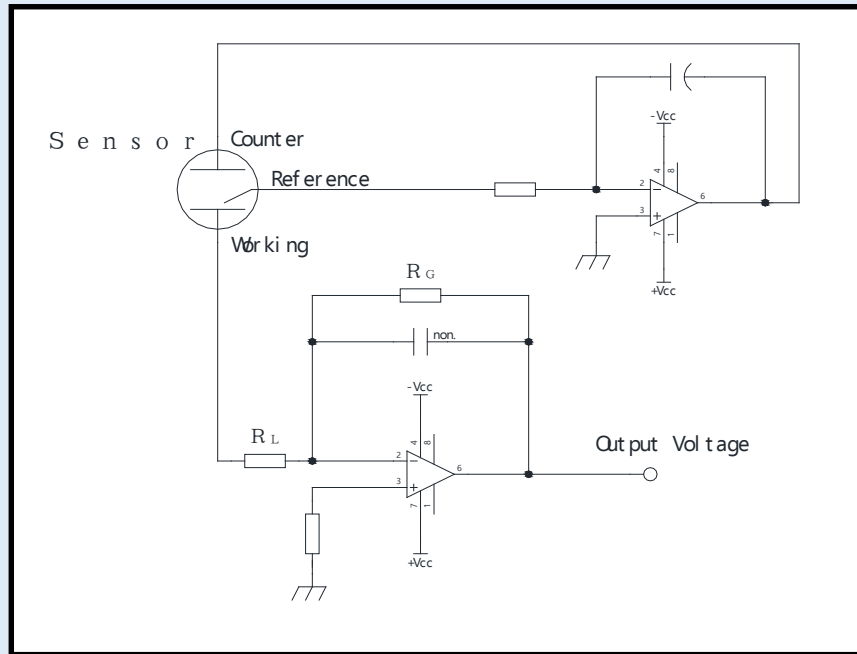

- In this arrangement, the output voltage =

$$\text{Gas Concentration (ppm)} \times \text{Cell Output (A)} \times R_G (\Omega)$$

- So if R_G is 10k, cell output is 70nA/ppm and gas concentration is 100ppm then

$$V_{OUT} = 100 \times (70 \times 10^{-9}) \times (10 \times 10^3) = 0.070V$$

- R_L is the cell load resistor (typically 7.5-33Ω). Speed of response can be increased by reducing the value of R_L, but signal noise may be increased as a consequence. The recommended values are shown on sensor datasheets
- Amplifiers should be high quality precision low input offset types, e.g. OP97 or similar
- Some sensors require temperature compensation circuitry. A simple compensation network can be incorporated into this circuit by replacing R_G with a thermistor. Typically this is a NTC thermistor that has 3435K of B constant adjusting the output accuracy to within ± 10% in the range of -10°C ~ 50°C. Any thermistor with a B-constant around 3500K and resistance value (R₂₅) of 10 KΩ can be used. Alternatively, temperature compensation may be undertaken using software lookup tables.



The circuit Nemoto employs for all its internal testing of NE4-CO is shown below:

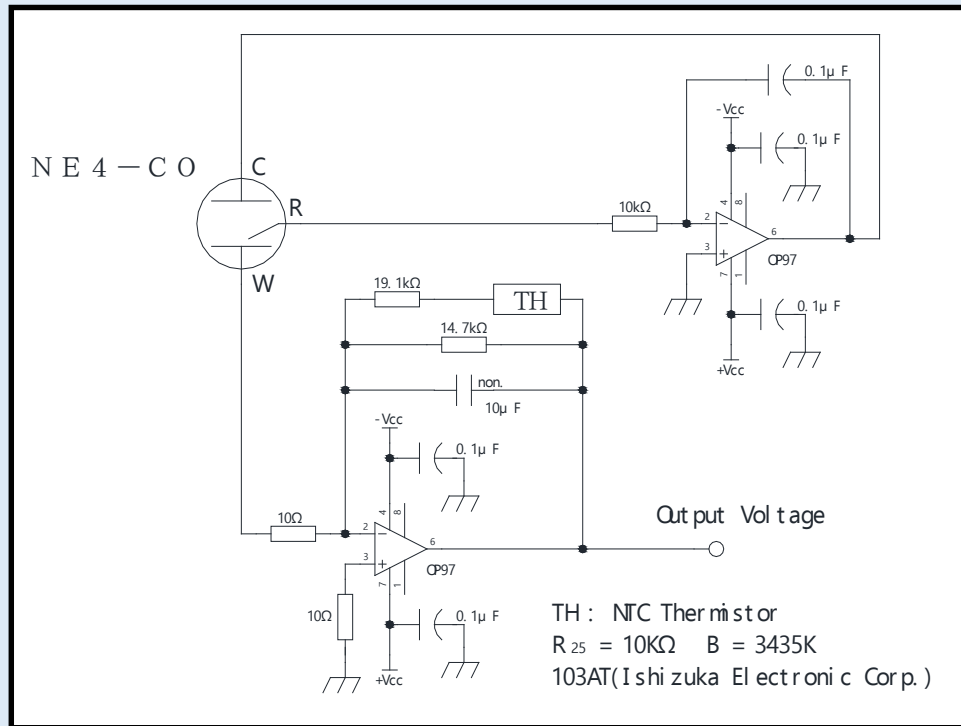

Nemoto recognises that the companies who use its gas sensing devices are themselves experts in circuitry design, often with more expertise than Nemoto in this area. The information given here is hence for initial guidance only, and Nemoto does not insist that instrument designers reproduce our circuitry guidance precisely. If the instrument designer deviates from this guidance significantly, however, Nemoto advises that we should be consulted to ensure that the proposed circuit design will function correctly.

Failure to adhere to the recommended circuitry outlined in this document without consultation with Nemoto may result in the suspension of the warranties which apply to the device.

GENERAL NOTES ON HANDLING, MANUFACTURE AND INSTRUMENT DESIGN

1) Long-term drift of gas sensitivity

All electrochemical gas sensors lose sensitivity over time due to small changes on the surface of the working electrode, reducing its oxidation capability. To reduce this, the NE4-CO uses a newly developed electrode catalyst that will not deteriorate by more than 5% / year. Typically, these changes are limited to less than 5% but we recommend that this deterioration should be taken into account when designing application circuits.

2) Environmental effects on gas sensitivity

Due to the hygroscopic nature of the electrolyte used in electrochemical sensors, moisture is absorbed from or released to the surrounding atmosphere. In high humidity moisture is absorbed, causing an increased sensitivity. In low humidity moisture is released back to the atmosphere and the sensitivity decreases. Conventional electrochemical gas sensors show annual variation of gas sensitivity as much as 10 ~ 20%.



The NE4-CO utilises an advanced electrolyte management design and, combined with the unique electrode catalyst structure, these changes can be greatly reduced. Under normal operating conditions, gas sensitivity should change by no more than $\pm 5\%$ of the output value. The NE4-CO is designed so that all changes due to moisture uptake/release are completely reversible.

If the gas intake area of the sensor is blocked with water drops or other liquid, gas cannot enter the sensor. The NE4-CO is fitted with an integral hydrophobic barrier to prevent this, but we recommend the use of additional membrane barriers if the sensor is in highly condensing RH conditions.

CO gas is almost the same weight as air, but as it is a combustion by-product it will usually be heated and therefore rise. CO detecting devices should be installed at least 5ft from the floor and preferable on the upper part of walls or ceilings.

If the sensor is to be used in more irregular atmospheres, please contact us for assistance.

3) Storage of sensors

Electrochemical sensors should be stored in a clean air under room temperature, preferably 0°C ~ 20°C and in non-condensing RH conditions. The maximum storage period would be 6 months after delivery. For sensors stored for more than 6 months, the life in service will be shortened by the excess storage period. Unlike semiconductor type or hot-wire type gas sensors, the gas sensitivity of electrochemical gas sensors will change as time passes regardless of whether sensor has been used or not.

4) Mounting of sensors

Electrode pins must be connected correctly to ensure operation.

If a thermistor is used for temperature compensation, it must be located near the sensor and away from heat sources such as transformers.

The NE4-CO can be mounted in any orientation.

NE4-CO connection pins cannot be soldered as excess heating may cause the deformation of the housing and eventually leakage of electrolyte.

5) Calibration and gas testing

Calibration of detectors or densitometers should be done after the output value has been stabilized in clean air.

Evaluation of gas sensitivity should be made in clean, humidified, air. When a test gas is blown directly to the gas intake area, higher gas sensitivity may be observed. It is therefore best to test and calibrate gas detection instruments and sensors in diffusion mode. This can be achieved by using a suitable test housing where a low flow rate is used (<1l/min) and where the air is agitated to ensure equal gas diffusion throughout.



6) Other

Unless otherwise advised by Nemoto, voltage should not be supplied directly to the electrode pins.

Do not bend the pins.

Do not apply more than 5 Kg/cm² of force to the sensor.

Take care not to block the gas intake area as it may prevent gas entering the sensor.

Never put foreign material in the gas intake area as it may cause the electrolyte leakage

Do not expose the sensor to excess vibration or shock.

If the sensor housing is damaged, do not use the sensor.

After the sensor is exposed to high concentration gas for long periods, the output signal may require time to recover to normal operation.

Do not blow organic solvents, paints, chemical agents, oils, or high concentration gases directly onto sensors.

Do not disassemble the sensor as this may cause electrolyte leakage.

DEFINITIONS

Baseline / Baseline shift: Baseline means the output level in clean air. The output current value at 20°C would be less than 450nA, but this tends to increase as the ambient temperature rises more than 30°C. The Baseline shift means this variation of the output level, i.e. a maximum of 900nA would be put out at 50°C. This Baseline shift should be taken into account to optimise overall accuracy. In this manual, the output values are calculated to be equivalent to CO gas concentrations.

Gas sensitivity / Output signals: Using the NE4-CO, 75 ± 15nA is generated at 1ppm of CO gas. For instance, the generated current value will be about 15µA at 200ppm of CO gas (200ppm x 75nA). This generated current is generally recorded as a voltage produced by a Current – Voltage converting circuit as illustrated in our recommended circuit, as the conversion is done through a resistor of 10 KΩ.

Response time (T₉₀): This is the time taken to reach to 90% of the maximum output value in clean air.

Repeatability: This is the maximum variation of output signals when tests are repeated under the same measuring conditions (temperature, humidity, gas concentration etc.). The repeatability of NE4-CO is ± 2%, and this means that all of the test results would fall in the range of 98% ~ 102%.

Temperature dependence: All electrochemical sensors are affected by changes in the ambient temperature and the output increases as the ambient temperature rises. This is caused by the rate of oxidation reaction on the surface of the catalyst, the dispersibility of the gas in the capillary, and the thermal effects on the mobility of ions in the electrolyte. This temperature dependency can be compensated relatively easily by using a NTC thermistor.